HP 64700 Series Emulators
Analyzer

PC Interface
User's Guide



HP Part No. 64740-97007
Printed in U.S.A.
August 1990
Edition 4

Notice

Hewlett-Packard makes no warranty of any kind with regard to this material, including, but not limited to, the implied warranties of merchantability and fitness for a particular purpose.

Hewlett-Packard shall not be liable for errors contained herein or for incidental or consequential damages in connection with the furnishing, performance, or use of this material.

Hewlett-Packard assumes no responsibility for the use or reliability of its software on equipment that is not furnished by Hewlett-Packard.

© Copyright 1987, 1988, 1990, Hewlett-Packard Company.

This document contains proprietary information, which is protected by copyright. All rights are reserved. No part of this document may be photocopied, reproduced or translated to another language without the prior written consent of Hewlett-Packard Company. The information contained in this document is subject to change without notice.

Advancelink, Vectra, and HP are trademarks of Hewlett-Packard Company.

IBM and PC AT are registered trademarks of International Business Machines Corporation.

MS-DOS is a trademark of Microsoft Corporation.

UNIX is a registered trademark of AT&T.

TORX is a registered trademark of Camcar Division of Textron, Inc.

**Hewlett-Packard Company
Logic Systems Division
8245 North Union Boulevard
Colorado Springs, CO 80920, U.S.A.**

Printing History

New editions are complete revisions of the manual. The date on the title page changes only when a new edition is published.

A software code may be printed before the date; this indicates the version level of the software product at the time the manual was issued. Many product updates and fixes do not require manual changes, and manual corrections may be done without accompanying product changes. Therefore, do not expect a one-to-one correspondence between product updates and manual revisions.

Edition 1	64740-90911 E1187	November 1987
Edition 2	64740-90911 E0988	September 1988
Edition 3	64740-97006	May 1990
Edition 4	64740-97007	August 1990

Using this Manual

This manual will show you how to use the HP 64700 series analyzer with the host computer PC Interface.

This manual will:

- Briefly introduce the analyzer and its features.
- Show you how to use the analyzer in its simplest, power-up condition. From there, it will progressively show you how and why you would use additional trace commands.
- Show you how to connect the external analyzer probe to target system signals and how to use the external analyzer as an extension of the emulation analyzer.
- Show you how to use the external timing analyzer via the Timing Interface.
- Show you how to set up the analyzer trigger to break the emulator into the monitor program.
- Show you how to drive external Coordinated Measurement Bus (CMB) or BNC trigger signals with the analyzer trigger.

This manual will not:

- Show you how to use every PC Interface command and option; the PC Interface is described in the *HP 64700 Emulators PC Interface: User's Reference*.

Organization

- Chapter 1** **Introducing the HP 64700 Series Analyzer.** This chapter lists the basic features of the analyzer. The following chapters show you how to use these features.
- Chapter 2** **Using the Internal Analyzer.** This chapter shows you how to use the internal emulation analyzer, and it describes the basic steps performed when using the analyzer.
- Chapter 3** **Internal Analyzer Examples.** This chapter contains examples of using the analyzer. It describes a sample program on which trace measurements are made, and then it shows you how to specify a simple trigger condition, how to use storage, prestore, and count qualifiers. This chapter also shows you how to use the sequencer and how to trace "windows" of program execution.
- Chapter 4** **Using the External Analyzer.** This chapter shows you how to connect the external analyzer probe to the target system and how to configure the external analyzer (it may be aligned with the internal analyzer, configured as an external state analyzer, or configured as an external timing analyzer). This chapter shows you how to use the external analyzer when it is aligned with the internal analyzer and when it is configured as an external state analyzer.
- Chapter 5** **Using the External Timing Analyzer.** This chapter shows you how to use the external timing analyzer. The external timing analyzer allows you to perform timing measurements and view the captured data in waveform displays.
- Chapter 6** **Making Coordinated Measurements.** This chapter shows you how to allow other HP 64700 emulators to start trace measurements, how to use the analyzer trigger condition to break the emulator, how to use the emulation analyzer trigger to drive external trigger signals, and how to allow the analyzers to be armed (turned on) by external trigger signals.

Contents

1	Introducing the HP 64700 Series Analyzer	
	Overview	1-1
	Analyzer Features	1-3
	Simple Measurements	1-3
	Trace Storage, Prestore, and Count	1-3
	Sequencer	1-3
	External Analysis	1-3
	External Timing Analysis	1-4
	Coordinated Measurements	1-5
2	Using the Internal Analyzer	
	Introduction	2-1
	Modifying the Trace Specification	2-1
	Sequence Levels	2-2
	Sequence Level Field	2-3
	Storage Qualifier Field	2-4
	Find State or Trigger on State Field	2-4
	Occurrence Count Field	2-5
	Branches	2-5
	Count	2-6
	Prestore	2-6
	Trigger Position	2-7
	Specifying State Patterns and Expressions	2-7
	Values	2-7
	Constants.	2-8
	Operators.	2-9
	Assigning Values to the Range Resource	2-10
	Assigning Values to the Pattern Resources	2-10
	Trace Labels.	2-10
	Predefined Values for 68000 Emulator Status.	2-11
	Specifying Pattern Expressions	2-12
	Intersect Operators.	2-12
	Intraset Operators.	2-12
	Set Operator Limitations.	2-13

Resetting the Trace Specification	2-13
Starting the Trace	2-13
Halting a Trace Measurement	2-14
Displaying the Trace	2-14
Changing the Trace Format	2-16
Tracing Foreground/Background Execution	2-16
Trace Labels	2-17

3 Internal Analyzer Examples

Introduction	3-1
Prerequisites	3-2
The Sample Program	3-2
What the Sample Program Does	3-2
Mapping Memory for the Sample Program	3-8
Loading the Sample Program	3-9
Set Up the Stack Pointer	3-10
Running the Sample Program	3-10
Activating the Trace Window	3-10
Specifying a Simple Trigger	3-11
Using Storage Qualifiers	3-15
Using Trace Prestore	3-18
Changing the Count Qualifier	3-21
Using "Restart On" Branches	3-24
Using Branches "Per Level"	3-27
Storing "Windows" of Program Execution	3-36
Excluding Windows of Program Execution	3-41
Triggering on a State Outside the Window	3-42
Using Multiple Trigger Levels	3-44

4 Using the External Analyzer

Introduction	4-1
Before You Can Use the External Analyzer	4-2
Assembling the Analyzer Probe	4-2
Connecting the Probe to the Emulator	4-4
Connecting Probe Wires to the Target System	4-7
Specifying Threshold Voltages & Defining Labels	4-9
Specifying Threshold Voltages	4-10
External Trace Signal Activity	4-10
Defining External Analyzer Labels	4-10
Selecting the External Analyzer Mode	4-11
Using the External Analyzer when Aligned with Internal	4-12

Using the External State Analyzer	4-14
Selecting the Clock Source	4-14
Specifying the Maximum Qualified Clock Speed	4-16
External Analyzer Specifications	4-17
External State Analyzer Specifications	4-17

5 Using the External Timing Analyzer

Introduction	5-1
Prerequisites	5-2
Configuring for Timing Analysis	5-2
Specifying Threshold Voltages & Defining Labels	5-3
Threshold Voltages	5-4
Activity	5-5
Labels	5-5
Timing Specification	5-6
Acquisition Modes	5-7
Transitional	5-7
Standard	5-9
Glitch	5-9
Sample Period	5-9
Armed By	5-9
Begin	5-9
TRIG1 or TRIG2	5-10
Trigger Position	5-10
Trigger Holdoff (Prestore)	5-10
Trigger Delay	5-10
Label Qualifier	5-11
Specifying the Trigger Condition	5-11
Find Pattern	5-12
Duration	5-12
Greater Than Duration	5-12
Less Than Duration	5-12
Then Find Edge or Glitch	5-14
Reset	5-14
Timing Waveform Display	5-17
Setting the Time per Division	5-17
Scrolling through the Waveform Display	5-18
Reference Points	5-18
Trigger	5-18
User Defined (X, O)	5-18
Cursor moves (X, O, X & O)	5-18

Magnify About (X or O)	5-18
Inserting/Deleting Channels	5-19
Examples	5-19
Starting the Timing Measurement	5-19
Halting the Trace	5-19
External Timing Analyzer Specifications	5-20

6 Making Coordinated Measurements

Introduction	6-1
Tracing at EXECUTE	6-3
Using the Analyzer Trigger to Break into the Monitor	6-3
Using the Analyzer Trigger to Drive External Signals	6-4
Allowing CMB or BNC TRIGGERs to Arm the Analyzer	6-5
Arming the Internal Emulation Analyzer	6-5
Arming the External Analyzer	6-6
Using One Analyzer to Arm the Other	6-7
Other Trigger Combinations	6-8

Illustrations

Figure 1-1. Block Diagram of HP 64700 Series Analyzer	1-2
Figure 2-1. Trace Specification Screen	2-2
Figure 2-2. Ranges, Patterns, and Expressions	2-8
Figure 2-3. Analysis Format Screen	2-17
Figure 3-1. Pseudo-Code Algorithm of Sample Program	3-3
Figure 3-2. Sample Program Listing	3-4
Figure 3-3. Memory Map Configuration Display	3-9
Figure 3-4. Simple Trigger Specification	3-11
Figure 3-5. Storage Qualifier Specification	3-16
Figure 3-6. Prestore Qualifier Specification	3-18
Figure 3-7. Count Qualifier Specification	3-21
Figure 3-8. Branches "Restart On" Specification	3-25
Figure 3-9. Tracing Last Write to RESULTS Area	3-29
Figure 3-10. Branches "Per Level" Specification	3-33
Figure 3-11. Storing a Window of Program Execution	3-37
Figure 3-12. Store "Window" Trace Specification	3-38
Figure 3-13. Excluding Windows of Program Execution	3-42
Figure 3-14. Triggering on a State Outside the Window	3-43
Figure 3-15. Using Multiple Trigger Levels	3-44
Figure 4-1. Assembling the Analyzer Probe	4-3
Figure 4-2. Attaching Grabbers to Probe Wires	4-4
Figure 4-3. Removing Cover to Emulator Connector	4-5
Figure 4-4. Connecting the Probe to the Emulator	4-6
Figure 4-5. Connecting the Probe to the Target System	4-8
Figure 4-6. Analysis Format Display	4-9
Figure 4-7. External Data in the Trace	4-13
Figure 4-8. Analysis Format Display	4-14
Figure 4-9. Qualified Clocks	4-15
Figure 5-1. Timing Interface Main Display	5-3
Figure 5-2. Timing Label Specification	5-4
Figure 5-3. Transitional Acquisition Mode	5-7

Figure 5-4. Standard Acquisition Mode	5-8
Figure 5-5. Glitch Acquisition Mode	5-8
Figure 5-6. Pattern Trigger	5-13
Figure 5-7. Edge Trigger	5-15
Figure 5-8. Glitch Trigger	5-16
Figure 5-9. Timing Waveform Display	5-17
Figure 6-1. Cross Trigger Configuration	6-4
Figure 6-2. Receiving External Signals	6-6
Figure 6-3. Using One Analyzer to Arm the Other	6-8

6-Contents



Introducing the HP 64700 Series Analyzer

Overview

This manual describes the HP 64700 Series analyzer. Each HP 64700 Series emulator contains an internal emulation analyzer. Some emulators may optionally contain an external analyzer.

The *emulation analyzer*, also known as the *internal analyzer*, captures emulator bus cycle information synchronously with the processor's clock signal. A *trace* is a collection of these captured states. The *trigger* state specifies when the trace measurement is taken. The *external analyzer* captures activity on signals external to the emulator, typically other target system signals.

The analyzer commands are the same in every emulator; consequently, this manual is shipped with every HP 64700 Series emulator ordered with the PC Interface. A block diagram of the analyzer is shown in figure 1-1.

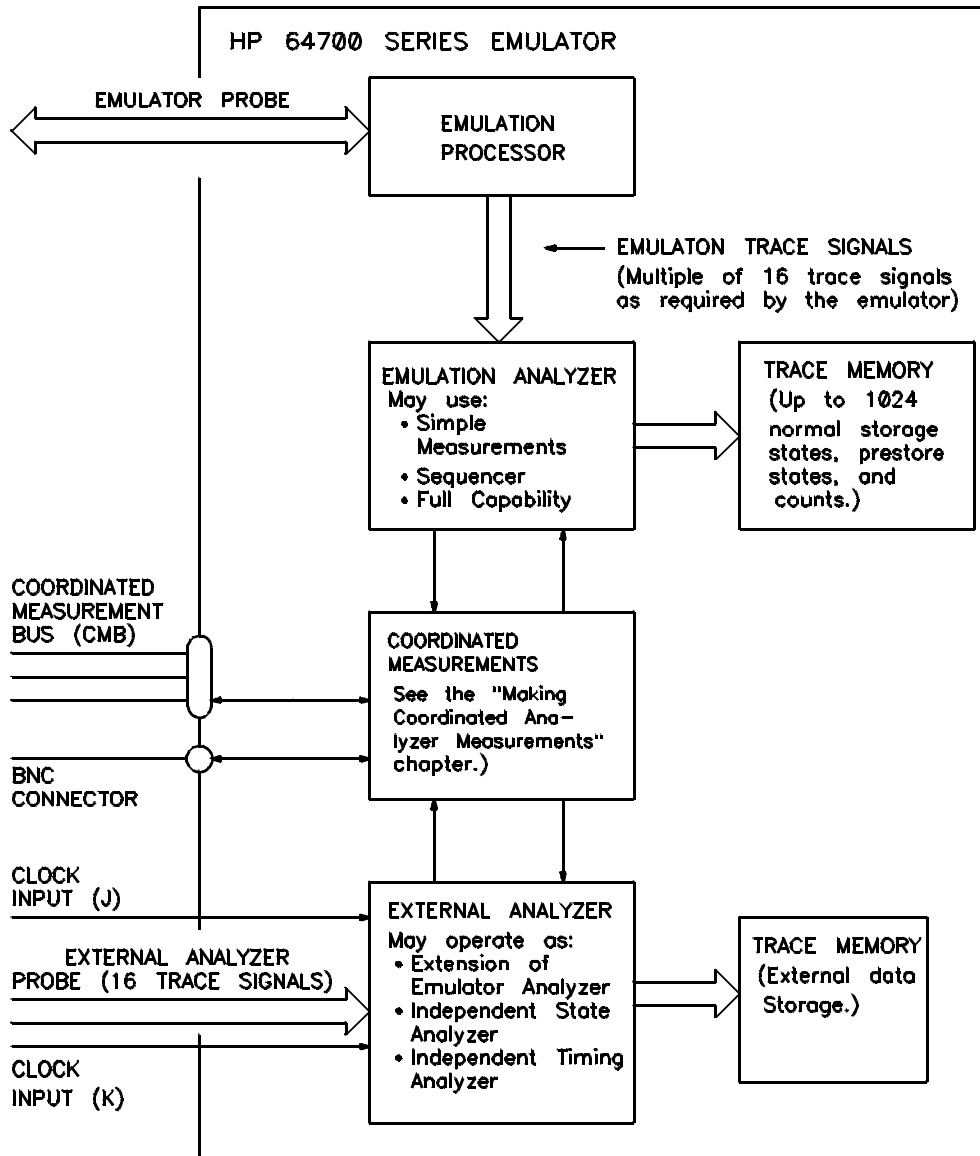

Figure 1-1. Block Diagram of HP 64700 Series Analyzer

1-2 Introduction

Analyzer Features

This chapter lists basic features of the HP 64700 Series analyzer. The chapters which follow show you how to use these features.

Simple Measurements

The default condition of the analyzer allows you to perform a simple measurement by entering a single "analysis begin" command. You can enter additional trace commands to qualify when execution should be traced and which bus cycle states should be stored.

Trace Storage, Prestore, and Count

The analyzer can store up to 1024 states in trace memory. These states can be normal storage states or prestore states (states which precede normal storage states). A count may be associated with normal storage states; you can specify that the analyzer count in either time or the occurrences of some state. When counts are specified, only 512 states can be stored.

Sequencer

You can use the analyzer to search for a particular sequence of states. The sequencer, which makes this possible, has several levels. Each level of the sequencer searches for a "find" or "trigger" state. When the find/trigger state is captured, the analyzer goes on searching at the following sequence level. If branches are turned on, a "branch" state is also searched for in each sequence level. If the branch state is found before the find/trigger state, the analyzer can jump to any sequence level where it continues searching for states.

External Analysis

Your HP 64700 Series emulator may optionally contain an external analyzer. The external analyzer provides 16 external trace signals and two external clock inputs. You can use the external analyzer as an extension to the emulation analyzer, as an independent state analyzer, or as an independent timing analyzer.



External Timing Analysis

If your emulator contains an external analyzer, you can configure the external analyzer to perform timing measurements. Some of the features of the external timing analyzer are listed below.

- Standard data acquisition mode with a maximum sample rate of 100 MHz (10 ns).
- Transitional data acquisition mode extends the storage time interval by storing only information changes and the time between them.
- Glitch data acquisition mode on all channels without reducing the number of channels.
- Trigger when signals on the external probe match a specified pattern for greater than or less than a specified time (duration). Edge and glitch qualifiers may be included in the trigger specification.
- You can place the trigger point at the start, center, or end of the trace to view signals after, about, or before the trigger.
- Timing Interface supports screen dumps to graphics printers (for printing waveform displays).

Note



The PC Interface requires EGA or VGA monitors and adapters to display timing waveforms.

Note



Two versions of the PC Interface are shipped with your emulator; one contains interface software for the timing analyzer and the other does not. The version that contains the timing interface software is larger and requires most of the PC's 640K bytes of RAM. The version that does not contain the timing interface software requires approximately 480K bytes of RAM.

Coordinated Measurements

When multiple HP 64700 Series emulators are connected via the Coordinated Measurement Bus (CMB), you can use the analyzer to trigger the analyzers of other emulators. You can also use the analyzer to trigger instruments connected to the BNC port. Conversely, the analyzer may be triggered by other emulators and instruments.

Also, if your emulator contains an external analyzer being used as an independent analyzer, coordinated measurements may take place between the internal emulation analyzer and the external analyzer.





Notes

1-6 Introduction

Using the Internal Analyzer

Introduction

This chapter describes how to use the emulation analyzer from within the PC Interface. The steps performed when using the analyzer are:

- Modifying the trace specification (or using the default).
- Starting the trace.
- Displaying the trace.

These steps are described in the main sections of this chapter.

Modifying the Trace Specification

The PC Interface's "Analysis Trace Modify" command provides one screen (with one subscreen) from which you make a complete trace specifications. This section describes the options available on those screens. To access the trace specification screen, select:

Analysis, Trace, Modify

Note



If your emulator contains an external analyzer (which can operate as an independent analyzer), you will have to include another option, "Internal", to specify which analyzer the command is for.

The trace specification screen (see figure 2-1) shows the sequence levels that are being used, the qualifiers associated with those levels,

the secondary branch mode, the count and prestore qualifiers, and the trigger position selection. When you initially enter the PC Interface, the default analyzer configuration specifies a trigger on any state, and that all captured states are stored.

Sequence Levels

The trace specification screen in figure 2-1 shows two sequence levels. At least two sequence levels will always be used because a trigger level is required and there must always be a level after the trigger level.

Each sequence level in the trace specification screen, except the last, has four associated fields; the sequence level field, the storage qualifier field, the find/trigger state field, and the occurrence count field. Only the sequence level field and the storage qualifier field are available in the last sequence level.

When you begin (start) a trace, the analyzer searches for the find/trigger state of the first sequence level; when that state is found, the analyzer searches for the find/trigger state of the second sequence level, and so on.

```
Internal State Trace Specification
1 While storing any state
  Trigger on any state 1 times

2 Store any state

Branches off      Count time      Prestore off     Trigger position
                                     start of 512

STATUS: M68000--Running user program      Emulation trace halted

Use the TAB and Shift-TAB keys to select a trigger position or enter a number.
```

Figure 2-1. Trace Specification Screen

2-2 Using the Analyzer

One of the sequence levels is specified as the trigger level. The analyzer triggers when it finds the state associated with this level. The trigger is the reference point in the resulting trace. States are stored before, after, or about the trigger state. The trigger state is always on line 0 of the trace.

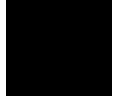

Sequence Level Field

The sequence level field shows the level (1 through 8) of the sequence term. This field also allows you to insert or delete sequence terms, or to specify the trigger level.

Move the cursor to the first sequence level field in the upper left corner of the screen, and use the **Tab** key to view the options associated with sequence levels. These options are:

- I Insert level.
- D Delete level.
- T Set the trigger level.

Select the "I" option and enter **Enter** to insert a new sequence level. Using the arrow cursor keys, reposition the cursor and repeat this process until eight sequence levels are used. This is the maximum number of sequence levels.

Note



When moving the cursor in the trace specification screen, use the arrow cursor keys. Using **Enter** (carriage return) in the state qualification fields causes the "patterns and expressions" screen to appear.

Move the cursor to level 5 and make this the trigger level by entering "T" and a **Enter**. Notice that level 5 now shows "Trigger on" instead of "Then find" while the previous trigger level now shows "Then find".

Move the cursor to the last sequence level and enter "D" and **Enter**. Notice that the previous level is deleted instead.

Now try to delete the trigger level. Notice that the following level is made the trigger level until it is the second to last; then, the previous level is made the trigger level.

Storage Qualifier Field

The storage qualifier field allows you to specify which states are stored while the analyzer searches for that sequence level's find or trigger state.

Move the cursor to a storage qualifier field and use the **Tab** key to scroll through the choices. You will see the following options:

any state	All states are stored.
no state	No states are stored.
r, !r	Only states in the range (r) or states not in the range (!r) are stored. Ranges are defined in the patterns and expressions screen described below.
a, b, c, d, e, f, g, h	Only states that match the pattern are stored. Up to eight different patterns can be defined. Patterns are defined in the patterns and expressions screen described below.
arm	Store only the state executing when the analyzer is armed (enabled) by some condition external to the analyzer. Conditions that can be used to arm the analyzer are described in the "Making Coordinated Measurements" chapter.

These same options are available in any state qualifier field.

Find State or Trigger on State Field

The "find state" or "trigger on" state field allows you to define the state that causes the analyzer to start searching for the following sequence level or that causes the analyzer to trigger.

The options available in this field are the same as for the storage qualifier field.

Occurrence Count Field

The occurrence count field specifies the number of times the state specified in the find/trigger field must be found before the analyzer goes on to the following sequence level.

The default base for an occurrence count is decimal. You may specify occurrence counts from 1 to 65535.

Branches

Branches alter the analyzer's search sequence if the specified branch state occurs before the find/trigger state.

When branches are turned off, the analyzer searches for the first sequence level's find/trigger state; when this state is found, the analyzer searches for the second sequence level's find/trigger state, and so on.

When branches are turned on, the analyzer searches for find/trigger states associated with each sequence level; if the find/trigger state is found before the branch state, the analyzer still continues its search at the following sequence level. However, if the branch state is found before the find/trigger state, the analyzer can continue its search at a different sequence level.

off	Branches are turned off. The analyzer searches only for the states defined in the find/trigger fields, starting with the first sequence level, then the second, and so on.
restart on	Branches are turned on. You are given another field in which to specify the restart state qualifier. This restart qualifier is used for all sequence levels, and the branch is always back to the first sequence level. This is also known as "global restart" because the same restart condition applies to all sequence levels.
per level	Branches are turned on. Two additional fields are added to each sequence level except the last: one for the branch state qualifier, and one to specify the sequence level the analyzer branches to if the branch state is found before the find/trigger state.

No branch state qualifier field is added to the last sequence level, but you are given a field in which to specify the sequence level the analyzer branches to when the "then find" state is found.

Count For each stored state, the analyzer can either count time or the number of occurrences of some state.

time Time counts are recorded for each stored state.

state The number of occurrences of some state are recorded for each stored state. You are given another field in which to specify the state count qualifier.

off Counting can be turned off to allow more states to be stored. When the analyzer counts states or time, 512 states can be stored in a trace. When counting is turned off, 1024 states can be stored in a trace.

Counts can be displayed in relative format (relative to the previous state) or absolute format (relative to the trigger state). Refer to the "Changing the Trace Format" section that appears later in this chapter.

Prestore Prestore allows you to store up to two states which match the prestore qualifier state before each normal store state. Prestore is useful, for example, in identifying the callers of a function or subroutine that is called from many places in the program.

off Prestore is turned off.

on Prestore is turned on. You are given another field in which to specify the prestore qualifier.

Trigger Position

The trigger position specifies where the trigger state appears in the trace.

center Use "center" when you are interested in states that occur before and after the trigger.

end Use "end" when you are only interested in states that occur before the trigger.

start Use "start" when you are interested only in states that occur after the trigger.

<number> In addition to start, center, and end, you can type in a number to specify the trigger position. For example, if you specify the trigger position as "10 of 512", nine states before the trigger will be stored, and 502 states will be stored after the trigger (assuming nine states must match the storage qualifiers before the trigger and 502 states must match the storage qualifiers after the trigger).

You will sometimes notice that the trigger position is not exact. The actual trigger position will be within +/- 1 state of the position specified if counting states or time; if the count qualifier is turned off, the actual trigger position will be within +/- 3 states of the number specified.

Specifying State Patterns and Expressions

Any time the cursor is in a state qualifier field, entering a **Enter** will cause the patterns and expressions screen to appear (see figure 2-2).

In the patterns and expressions screen, you assign values to the range and pattern resources and you combine these resources to create the pattern expression.

Values

When assigning values to the range and pattern resources, you can use symbols (in the address field only) or numeric constants in several

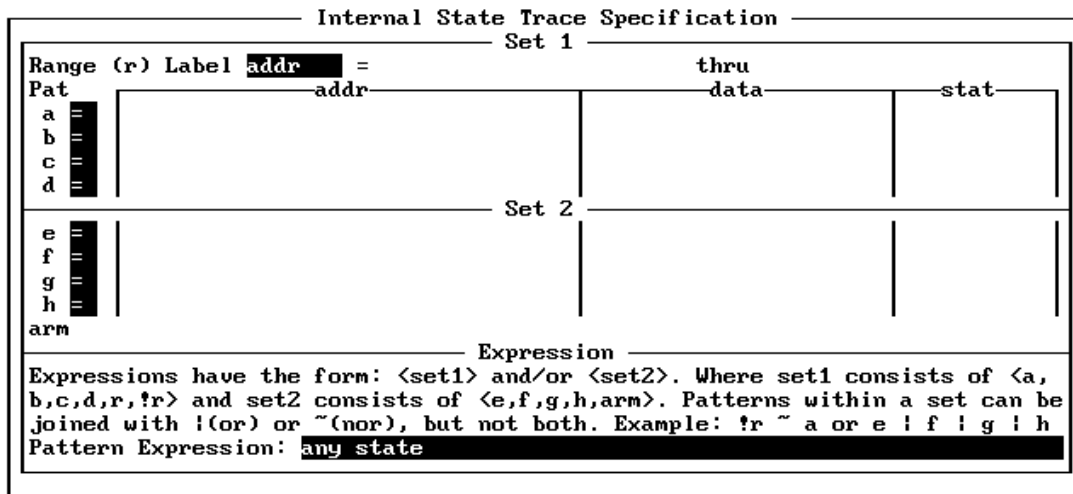

STATUS: M68000--Running user program Emulation trace halted

TAB selects a simple pattern or enter an expression or move up to edit patterns.

Figure 2-2. Ranges, Patterns, and Expressions

number bases (including predefined equates in the status field only). You can also use operators to combine symbols and numeric constants.

Constants. Values may be specified as numeric constants in hexadecimal, decimal, octal, or binary. The number bases are specified by the following characters:

- Y y** Binary (example: 10010110y).
- Q q O o** Octal (example: 377o or 377q).
- T t** Decimal (example: 2048t).
- H h** (or no base) Hexadecimal (example: 0a7fh or 0a7f). (The leading digit of a hexadecimal constant must be 0-9.)

Don't care digits may be included in binary, octal, or hexadecimal numbers and they are represented by the characters **X** or **x**. A value of

all don't cares may be represented by a question mark (?) or a blank field.

Operators. Values can also be symbols and numeric constants combined with operators. All operations are carried out on 32-bit, two's complement integers. (Values which are not 32 bits will be sign extended when expression evaluation occurs.)

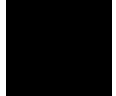

The available operators are listed below in descending order of evaluation precedence. Parentheses are also allowed in expressions to change the order of evaluation.

-, ~	Unary two's complement, unary one's complement. The unary two's complement operator is not allowed on constants containing don't care bits.
*, /, %	Integer multiply, divide, and modulo. These operators are not allowed on constants containing don't care bits.
+, -	Addition, subtraction. These operators are not allowed on constants containing don't care bits.
<<, <<<, >>, >>>	Shift left, rotate left, shift right, rotate right.
&	Bitwise AND.
^	Bitwise exclusive or, XOR.
 	Bitwise inclusive OR.
&&	Logical AND/bit-wise merge. When bits are different, the first value overrides the second; e.g., 10xxy && 11x1y == 10x1y.

Refer to the *PC Interface: User's Reference* description of **expr** for operator truth tables.

Assigning Values to the Range Resource

The range resource defines a range of values associated with a particular trace label. Move the cursor to the range label field and use the **Tab** key to view the predefined trace labels. Notice that these labels are also used when assigning values to the pattern resources. Trace labels are described in the "Assigning Values to the Pattern Resources" section that follows.

Pressing the right arrow key moves the cursor to the starting value field. Notice that you are given a line in the bottom part of the display in which to enter the value. The value you enter on this line may be longer than the space available in the starting value field; when this happens, as much of the value as possible is shown in the starting value field. Pressing the right arrow key again moves the cursor to the ending value field.

Assigning Values to the Pattern Resources

You can assign address, data, status, and xbits (if an external analyzer is present) values to each of the pattern resources.

Move the cursor to the field to the immediate right of a pattern resource and press the **Tab** key a couple times. When "=" is selected, the pattern is equal to the state described by the following values; when "!=" is selected, the pattern is not equal to the state described.

The addr, data, stat, and xbits (if an external analyzer is present) columns allow you to assign values to each of the trace labels. When a pattern has values assigned to more than one trace label, these values are ANDed. In other words, if you assign an address value of 500H and a data value of 1234H to a pattern, a captured state must have an address of 5FFH AND data equal to 1234H in order to match the pattern.

Trace Labels. The following trace labels are predefined in most of the HP 64700 Series emulators:

addr	Represents the trace signals which monitor the emulation processor's address pins (trace signals 0 through 23 in the 68000 emulator).
------	---

data	Represents the trace signals which monitor the emulation processor's data pins (trace signals 32 through 47 in the 68000 emulator).
stat	Represents the trace signals which monitor other emulation processor signals (trace signals 24 through 31 in the 68000 emulator).
xbits	Represents the external trace signals. This trace label is only available if an external analyzer is present and aligned with the internal analyzer.

These trace labels are predefined. You can define additional trace labels in the screen presented with the "Analysis Format" command. Refer to the "Changing the Display Format" section that appears later in this chapter.

The trace signals associated with the addr, data, and stat trace labels are different for each emulator. Other emulators may provide additional trace labels to choose from.

Predefined Values for 68000 Emulator Status. Move the cursor to the "stat" field of a pattern resource. Notice that a line on which you can enter status values appears on the bottom part of the screen. Use the **Tab** key to view the predefined values. The predefined values for the 68000 emulator are:

Qualifier	Status Bits (31..24)	Description
byte	0xxxx xxx1Y	Byte cycle.
cyc6800	0xxxx x0xxY	6800 peripheral cycle.
data	0xxx0 1xxxY	Data cycle.
dma	0xx01 1xxxY	DMA cycle.
grd	00xxx xxxxY	Guarded memory access.
intack	0xx11 1xxxY	Interrupt acknowledge cycle.
prog	0xxx1 0xxxY	Program cycle.
read	0xxxx xx1xY	Read cycle.
super	0xx1x xxxxY	Supervisor cycle.
supdata	0xx10 1xxxY	Supervisor data cycle.
supprog	0xx11 0xxxY	Supervisor program cycle.
user	0xx0x xxxxY	User cycle.
userdata	0xx00 1xxxY	User data cycle.
userprog	0xx01 0xxxY	User program cycle.
word	0xxxx xxx0Y	Word cycle.
write	0xxxx xx0xY	Write cycle.
wrrom	0x0xx xx0xY	Write to ROM.

You can also select these predefined values when specifying status values for the pattern resources.

The predefined values for emulator status are different for each emulator. Refer to your *PC Interface: Emulator User's Guide* for the definitions of the status values predefined for your emulator.

Specifying Pattern Expressions

The range and pattern resources and the arm condition are split into two sets.

Set 1: **r**, **!r**, **a**, **b**, **c**, and **d**.

Set 2: **e**, **f**, **g**, **h**, and **arm**.

Interset Operators. Resources from the two sets can be combined with the **and** and **or** interset (between set) operators.

- You cannot use these operators to combine resources from the same set.

Intraset Operators. Resources within a set may be combined using one of the intraset operators, **|** (OR) or **~** (NOR).

- You cannot use both **|** (OR) and **~** (NOR) operators within the same set.
- You cannot combine resources from different sets with the **|** (OR) or **~** (NOR) operators.
- Note that "a ~ a" is allowed; this type of expression may occasionally be useful if you are running out of pattern resources and wish to specify a logical NOT of some existing pattern.

The intraset (within a set) operators (**~**, **|**) are evaluated first; then, the interset operators are evaluated.

Set Operator Limitations. Only the OR (|) and NOR (~) logical operators are available as intraset operators. However, you can create the AND and NAND operators by applying DeMorgan's law:

$$\begin{aligned} a \text{ AND } b &= \overline{a \sim b} \\ a \text{ NAND } b &= a | b \end{aligned}$$

To create a logical NOT of a pattern resource, invert the equality used when assigning values to that resource.

Resetting the Trace Specification

You can reset the analyzer to its default specification by selecting:

Analysis, Trace, Reset

The resulting trace specification is shown in figure 2-1.

Starting the Trace

After the trace specification has been made, you can start the trace by selecting:

Analysis, Begin

The emulator must be running before the analyzer can capture program execution.

When the trigger state has been found and trace memory has been filled with states, a message on the status line will show you that the trace is complete. When the status line shows you that the trace is complete, the next step is to display the trace.

If the status line continues to show that the trace is "running", two things are possible:

1. The trigger has been found, but there haven't been enough storage states captured to fill the trace memory buffer.
2. The trigger has not been found.

To find out which of these situations is the case, enter the "Analysis Display" command (described later in this chapter). The number of

states that can be displayed is shown at the bottom of the screen. If there are states to display, then situation 1 above has occurred.

If there are no states to display, then situation 2 above has occurred. If the trigger state has not been found and you think it should have been found, you may want to halt the trace and review your trace specification.

Halting a Trace Measurement

You can, and most likely will, specify traces whose trigger or storage states are never found. When this happens, the "Trace complete" message is never shown, and the trace continues to run ("Trace running"). When these situations occur, you can choose to halt the trace measurement. To do this, select:

Analysis, Halt

The trace halt command is also useful to deactivate signals which are driven when the trigger is found (refer to the "Making Coordinated Measurements" chapter).

Displaying the Trace

To display the trace, select:

Analysis, Display

If states have been stored, you are now given two fields in which to specify the states to display. Type the number of the first state you want to display in the "Starting state to display" field, and press **Enter**. Use the right arrow key to move the cursor to the "Ending state to display" field. Type in the number of the last state you want to display, and press **Enter**.

If your emulator supports symbol storage, you see an additional field that gives you control of the display of addresses and symbols.

An example trace display is shown below.

Analysis					
Line	addr,H	68000 Mnemonic,H		count,R	seq
0	00047e	ORI.B	#000,D0	---	+
1	000480	0600	supr prog	0.480 uS	.
2	000482	CLR.W	D0	0.520 uS	.
3	000600	0049	supr data wr word	0.480 uS	.
4	000602	3afc	supr data wr word	0.520 uS	.
5	000484	SWAP.W	D0	0.480 uS	.
6	000486	ANDI.L	#000000ff,D0	0.520 uS	.
7	000488	0000	supr prog	0.480 uS	.
8	00048a	00ff	supr prog	0.520 uS	.
9	00048c	RTS		0.480 uS	.
10	00048e	1340	unused prefetch	0.520 uS	.
11	000bfa	0000	supr data rd word	1.000 uS	.
12	000bfc	0412	supr data rd word	0.480 uS	.
13	000412	BTST.L	#01,D1	0.520 uS	.
14	000414	0001	supr prog	0.480 uS	.
15	000416	BEQ.W	000041c	0.520 uS	.

STATUS: M68000--Running user program Emulation trace complete
Window System Register Processor Breakpoints Memory Config Analysis
Begin Halt CMB Format Trace Display

The first column on the trace list contains the line number. The trigger is always on line 0.

The second column contains the address information associated with the trace states. Addresses in this column may be locations of instruction opcodes on fetch cycles, or they may be sources or destinations of operand cycles.

The third column shows mnemonic information about the emulation bus cycle. The disassembled instruction mnemonic is shown for opcode fetch cycles. The data and mnemonic status ("0600 supr prog", for example) are shown for operand cycles.

If your emulator contains an external analyzer (the model number has an "L" suffix), the next column, labeled "xbits", shows the data captured on the external channels.

The next column shows the count information (time is counted by default). The "R" indicates that each count is relative to the previous state.

The last column contains information about the sequencer. The "+" on line 0 indicates the state caused a sequencer branch (in this case, the trigger on any state).

Sometimes, the trace will show opcode fetches for instructions which are not executed because of a transfer of execution to other addresses. This can happen with microprocessors like the 68000 and the 80186 because they have pipelined architectures or instruction queues which allow them to prefetch the next few instructions before the current instruction is finished executing.

Note



When a trigger condition is found but not enough states are captured to fill trace memory, the status line will show that the trace is still running. You can display all but the last few captured states in this situation; you must halt the trace to display the last few captured states.

Changing the Trace Format

To change the trace format, select:

Analysis, **F**ormat

The analysis format screen is shown in figure 2-3.

The "Anlysis Format" command primarily allows you to arrange the columns of trace information in a different manner. However, notice that you can include any trace label in the trace. Also, notice that the trace label information can be displayed in various number bases, and that counts can be displayed relative or absolute.

Tracing **F**oreground/**B**ackground Execution

The first field in the "Analysis Format" display specifies whether the analyzer should capture user (foreground) states, background states, or all states (foreground and background). When background states appear in the trace, a string indicating that it is a background state typically appears at the end of the mnemonic column (for example, "BGM" appears when using the 68000 emulator).

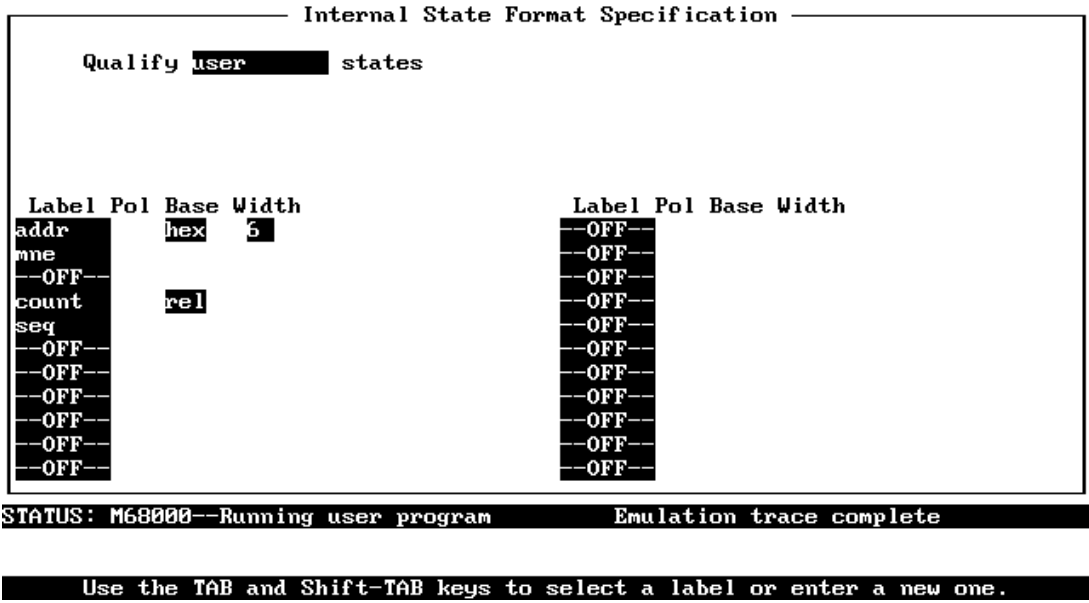

Figure 2-3. Analysis Format Screen

Trace Labels

The bottom part of the "Analysis Format" display is used to specify which trace labels appear in which column of the display. Several trace labels are predefined for the internal emulation analyzer.

You can specify the number base (in hexadecimal, binary, octal, decimal, and ASCII) for several of the predefined trace labels.

- addr Values captured on the emulator's address bus. If your emulator supports symbol storage, you can change the width of the address column so that more symbol information is shown.

- data Values captured on the emulator's data bus.

- stat Values captured on the trace signals used for the emulator's status.

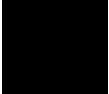

mne	Captured information disassembled and presented in mnemonic format.
count	State or time count information presented in absolute format (relative to the trigger state) or relative format (relative to the previous state in the trace).
seq	Shows a "+" if the captured state is one the analyzer was searching for and found (in other words, a find state, a trigger state, or an branch state).
DELETE	Deletes a trace label.
--OFF--	Turns a column off so that it is not displayed in the trace.

This concludes the "Using the Analyzer" chapter. You have learned about the analysis commands and all the trace specification fields except those that appear when you emulator contains an external analyzer. The additional fields are described in the "Using the External Analyzer" chapter.

Internal Analyzer Examples

Introduction

This chapter shows you how to use the emulation analyzer from within the PC Interface. It shows you how to make simple measurements as well as how to search for a sequence of states.

This chapter describes:

- The sample program on which example measurements are made.

This chapter provides the following examples of using the analyzer:

- Specifying a simple trigger.
- Using storage qualifiers.
- Using trace prestore.
- Changing the count qualifier.
- Trace a sequence of events using global restart.
- Trace a sequence of events while specifying "else" branches per level.
- Storing a "window" of program execution.
- Using multiple trigger levels.

Prerequisites

Before reading this chapter you should already know how the emulator operates. You should know how to use the PC Interface, and how to control the emulator from within the PC Interface. Refer to the appropriate *PC Interface: Emulator User's Guide* manual to learn about the emulator; then, return to this manual.

The Sample Program

The sample program is used to illustrate analyzer examples. The examples in this chapter have been generated using an 68000 (HP 64742) emulator. The sample program is written in 68000 assembly language.

It is not important that you know the 68000 assembly language; however, you should understand what the various sections of the program do and associate these tasks with the labels used in the program.

You are encouraged to rewrite the sample program in the assembly language appropriate for your emulator. Then, you can use your analyzer to perform the examples shown in this chapter. Of course, the output of your commands will be different than those shown here.

What the Sample Program Does

A pseudo-code algorithm of the sample program is shown in figure 3-1.

The sample program is not intended to represent a real routine. The program uses four different callers of the `WRITE_NUMBER` subroutine to simulate situations in real programs where routines are called from many different places. An example later in this chapter will show you how to use the analyzer to determine where a routine is called from.

```

Initialize the stack pointer.
Set up number counter.
AGAIN: Save the two previous random numbers.
Call the RAND random number generator subroutine.
Test the two least significant bits of the previous random number.
    If 00B then goto CALLER_0.
    If 01B then goto CALLER_1.
    If 10B then goto CALLER_2.
    If 11B then goto CALLER_3.
CALLER_0: Call the WRITE_NUMBER subroutine.
Goto AGAIN (repeat program).
CALLER_1: Call the WRITE_NUMBER subroutine.
Goto AGAIN (repeat program).
CALLER_2: Call the WRITE_NUMBER subroutine.
Goto AGAIN (repeat program).
CALLER_3: Call the WRITE_NUMBER subroutine.
Decrement number counter.
If the number counter is not zero
    Then goto AGAIN (repeat program).
Else
    Reset number counter.
    Push parameters for QSORT.
    Call QSORT.

RAND: Pseudo-random number generator which returns a random number
from 0-0FFH.
RETURN from subroutine.

WRITE_NUMBER: Write the random number to a 256 byte data area, using the second
previous random number as an offset into that area.
RETURN from subroutine.

QSORT: Quick-sort values in 256 byte data area.

```

Figure 3-1. Pseudo-Code Algorithm of Sample Program

An assembler listing of the sample program is shown in figure 3-2. It is provided so that you can see the addresses associated with the program labels. The program area, which contains the instructions to be executed by the microprocessor, is located at 400H. The RESULTS area, to which the random numbers are written, is located at 500H. The area which contains a variable used by the RAND subroutine and the locations for the stack is located at 600H.

Before you can use the analyzer to perform measurements on the sample program, you must map memory and load the sample program.

HEWLETT-PACKARD: 68000 Assembler
 FILE: C:\MNL\ODY\ANLY\PCI\SRC\68K\SRND.S
 LOCATION OBJECT CODE LINE SOURCE LINE

```

1 "68000"
2 *****
3 * The "srnd.S" program runs in an infinite loop,
4 * writing random numbers to an output area and
5 * sorting the output area after 4FFH random
6 * numbers have been written.
7 *****
8             ORG     400H
9 ;-----
10 ; Initialize the stack, and set up the counter
11 ; for the number of random numbers before sort.
12 ;-----
13 START      MOVE.L  #STACK,A7
14
15             MOVE.W #4FFH,D2
16 ;-----
17 ; The next two instructions move the second
18 ; previous random number into A1 (offset to
19 ; RESULTS area, and the previous random number
20 ; into D1.
21 ;-----
22 AGAIN      MOVE.L  D1,A1
23             MOVE.L  D0,D1
24 ;-----
25 ; RAND returns random number in D0.
26 ;-----
27             BSR     RAND
28 ; The following instructions determine which
29 ; caller calls WRITE_NUMBER (depends on last
30 ; two bits of the previous random number).
31 ;-----
32             BTST   #1,D1
33             BEQ   ZERO_ONE
34             BRA.B TWO_THREE
35 ZERO_ONE   BTST   #0,D1
36             BEQ   CALLER_0
37             BRA.B CALLER_1
38 TWO_THREE BTST   #0,D1
39             BEQ   CALLER_2
40             BRA.B CALLER_3
41 ;-----
42 ; The WRITE_NUMBER routine is called from four
43 ; different places. The program is repeated
44 ; after the subroutine return.
45 ;-----
46 CALLER_0  BSR     WRITE_NUMBER
47             BRA.B  TEST
48 CALLER_1  BSR     WRITE_NUMBER
49             BRA.B  TEST
50 CALLER_2  BSR     WRITE_NUMBER
51             BRA.B  TEST
52 CALLER_3  BSR     WRITE_NUMBER

```

Figure 3-2. Sample Program Listing

3-4 Examples

```

000446 0C42 0000    53 TEST                CMPI    #0,D2
54 ;-----
55 ; If the counter is not zero, continue to write
56 ; random numbers.
57 ;-----
00044A 57CA FFBE    58                    DBEQ    D2,AGAIN
59 ;-----
60 ; The counter is zero. Sort the random numbers
61 ; in the RESULTS area.
62 ;-----
00044E 343C 04FF    63                    MOVE.W #4FFH,D2 ; Reset counter.
64 ;-----
65 ; Push the "high address" and "low address"
66 ; parameters expected by the QSORT routine.
67 ;-----
000452 2F3C    68                    MOVE.L #RESULTS+0FFH,-[A7]
000454 000005FF
000458 2F3C    69                    MOVE.L #RESULTS,-[A7]
00045A 00000500
70 ;-----
71 ; Call the QSORT routine. Increment the
72 ; stack pointer after the call.
73 ;-----
00045E 6100 0034    74                    BSR.W  QSORT
000462 DFFC    75                    ADDA.L #8,A7
000464 00000008
000468 60A0    76                    BRA.B  AGAIN ; Repeat program.
77
78 *****
79 * The RAND routine generates a pseudo-random
80 * number from 0-0FFH, and leaves the result
81 * in D0.
82 *****
00046A 2039 0000    83 RAND                MOVE.L RAND_SEED,D0
00046E 0600
000470 C1FC 4E6D    84                    MULS.W #4E6DH,D0
000474 2040    85                    MOVEA.L D0,A0
000476 41E8 0339    86                    LEA    339H[A0],A0
00047A 2008    87                    MOVE.L A0,D0
00047C 23C0 0000    88                    MOVE.L D0,RAND_SEED
000480 0600
000482 4240    89                    CLR.W  D0
000484 4840    90                    SWAP  D0
000486 0280    91                    ANDI.L #000000FFH,D0
000488 000000FF
00048C 4E75    92                    RTS
93
94 *****
95 * The WRITE_NUMBER routine writes the random
96 * number to the RESULTS area. The second
97 * previous number is the offset in this area.
98 *****
00048E 1340 0500    99 WRITE_NUMBER        MOVE.B D0,RESULTS[A1]
000492 4E75    100                   RTS
101
102 *****

```

Figure 3-2. Sample Program Listing (Cont'd)

```

103 * The QSORT subroutine is passed (on the stack)
104 * the high and low addresses of an area of bytes
105 * to be sorted.
106 *****
000494 226F 0008 107 QSORT          MOVE.L 8[A7],A1 ; A1 = high index.
000498 206F 0004 108                MOVE.L 4[A7],A0 ; A0 = low index.
109 ;-----
110 ; The following section splits the area to be sorted
111 ; into two areas.  QSORT will be called to sort each
112 ; of these smaller areas.
113 ;
114 ; If high index is less than low index, then sort
115 ; is done.
116 ;-----
00049C B3C8      117 OVER          CMPA.L A0,A1
00049E 6F00 0054 118                BLE     DONE
119 ;-----
120 ; D2 = dividing value (from low index).
121 ;-----
0004A2 1410      122                MOVE.B [A0],D2
123 ;-----
124 ; (Increment allows DEC_HIGH loop to work first
125 ; time through.)
126 ;-----
0004A4 5289      127                ADDQ.L #1,A1
128 ;-----
129 ; Move low index up until it points to a value
130 ; greater than the dividing value.
131 ;-----
0004A6 5288      132 INC_LOW       ADDQ.L #1,A0
0004A8 B410      133                CMP.B [A0],D2
0004AA 6F00 000A 134                BLE     DEC_HIGH
0004AE B3C8      135                CMPA.L A0,A1
0004B0 6D00 0018 136                BLT     OUT
0004B4 60F0      137                BRA.B INC_LOW
138 ;-----
139 ; Move high index down until it points to a value
140 ; less than or equal to the dividing value.
141 ;-----
0004B6 5389      142 DEC_HIGH      SUBQ.L #1,A1
0004B8 B411      143                CMP.B [A1],D2
0004BA 6DFA      144                BLT     DEC_HIGH
145 ;-----
146 ; If high index is less than or equal to low index,
147 ; the area is split; do not swap values.
148 ;-----
0004BC B3C8      149                CMPA.L A0,A1
0004BE 6D00 000A 150                BLT     OUT
151 ;-----
152 ; If high index is greater than low index, swap
153 ; values and move indexes again.
154 ;-----
0004C2 1610      155                MOVE.B [A0],D3
0004C4 1091      156                MOVE.B [A1],[A0]
0004C6 1283      157                MOVE.B D3,[A1]
0004C8 60DC      158                BRA.B INC_LOW

```

Figure 3-2. Sample Program Listing (Cont'd)

```

159 ;-----
160 ; A0 = low address (needed to swap dividing value).
161 ;-----
0004CA 206F 0004 162 OUT          MOVE.L  4[A7],A0)
163 ;-----
164 ; Swap dividing value and high index value.
165 ;-----
0004CE 1091 166          MOVE.B  [A1],[A0]
0004D0 1282 167          MOVE.B  D2,[A1]
168 ;-----
169 ; The area is now split into two smaller areas.
170 ; The last high index value is the middle of the
171 ; two areas.  The high and low addresses for the
172 ; second QSORT call are pushed first.
173 ;-----
0004D2 2F2F 0008 174          MOVE.L  8[A7],[-[A7]  ; Push high.
0004D6 5289 175          ADDQ.L  #1,A1
0004D8 2F09 176          MOVE.L  A1,-[A7]  ; Push middle + 1.
0004DA 5589 177          SUBQ.L  #2,A1
0004DC 2F09 178          MOVE.L  A1,-[A7]  ; Push middle - 1.
0004DE 2F08 179          MOVE.L  A0,-[A7]  ; Push low.
0004E0 6100 FFB2 180          BSR.W   QSORT
181 ;-----
182 ; Increment stack pointer after call.
183 ;-----
0004E4 DFFC 184          ADDA.L  #8,A7
0004E6 00000008 185          BSR.W   QSORT
0004EA 6100 FFA8 186          ADDA.L  #8,A7
0004EE DFFC 187 DONE          RTS
0004F0 00000008 188
0004F4 4E75 189 *****
190 * Random numbers written to this area.
191 *****
000500 192          ORG     500H
193 RESULTS  DS.B   100H
194
195 *****
196 * Variable used in RAND subroutine and stack area.
197 *****
000600 0000 0001 198          ORG     600H
000604 199 RAND_SEED DC.L   1
000BFE 200          DS.W   2FDH
201 STACK   DS.W   1
          END     START
Errors= 0

```

```

CROSS REFERENCE TABLE FILE: C:\MNL\ODY\ANLY\PCI\SRC\68K\SRND.S
LINE#  SYMBOL          TYPE      REFERENCES
21  AGAIN              A        58, 76
46  CALLER_0          A        36
48  CALLER_1          A        37

```

Figure 3-2. Sample Program Listing (Cont'd)

50	CALLER_2	A	39			
52	CALLER_3	A	40			
142	DEC_HIGH	A	134,	144		
187	DONE	A	118			
132	INC_LOW	A	137,	158		
162	OUT	A	136,	150		
117	OVER	A				
107	QSORT	A	74,	180,	185	
83	RAND	A	26			
199	RAND_SEED	A	83,	88		
193	RESULTS	A	68,	69,	99	
201	STACK	A	13			
13	START	A	202			
53	TEST	A	47,	49,	51	
38	TWO_THREE	A	34			
99	WRITE_NUMBER	A	46,	48,	50,	52
35	ZERO_ONE	A	33			

Figure 3-2. Sample Program Listing (Cont'd)

Mapping Memory for the Sample Program

The program, destination, and stack areas of the sample program were ORGed at addresses 400H, 500H, and 600H, respectively. Therefore, map the range from 400H through 0BFFH to emulation memory before loading the program. Select the memory mapper configuration by either by using the left and right arrow keys to highlight command options and pressing **Enter**, or by typing the first letter of the command options.

Config, Map, Modify

Using the arrow keys, move the cursor to the "address range" field of term 1. Enter:

400..0bff

Move the cursor to the "memory type" field of term 1, and press the TAB key to select the **eram** (emulation RAM) type. To save your memory map, use the **Enter** key to exit the field in the lower right corner. (The **End** key on Vectra keyboards moves the cursor directly to the last field.) The memory configuration display is shown in figure 3-3.

Memory mapping is described in more detail in your *PC Interface: Emulator User's Guide*.

3-8 Examples

```

Memory Map Configuration
Unmapped memory type tram
Term      Address Range      Memory Type
1 400..0bff
2 Empty
3 Empty
4 Empty
5 Empty
6 Empty
7 Empty
eram
grd
grd
grd
grd
grd
grd

<↑↓> :Interfield movement  CTRL ←> :Field editing  TAB :Scroll choices
STATUS: M68000--Emulation reset      Emulation trace halted
Use the TAB and Shift-TAB keys to pick memory type for mapped range.

```

Figure 3-3. Memory Map Configuration Display

Loading the Sample Program

If you have already assembled and linked the sample program, you can load the absolute file by selecting:

Memory, Load

Move the cursor to the "Format" field and select the appropriate format (HP64000 in this example). Select "yes" in the field that forces the absolute file to be read. Now move the cursor to the "Absolute filename" field and enter the name of your symbol file (SRND.L in this example). The options available when loading absolute files into memory are described in more detail in the *PC Interface: User's Reference* manual.

Set Up the Stack Pointer

The 68000 emulator requires you to set up the system stack pointer before you can run the program. To set up the system stack pointer, you must first break into the monitor.

Processor, Break

To modify the system stack pointer, select:

Register, Modify

Use the **Tab** key to select register **ssp**, press **Enter**, type in the address 0BFEH, and press **Enter** once again.

Running the Sample Program

To start the emulator executing the sample program, select:

Processor, Go, Address

Type in the module and symbol names associated with the sample program's starting address, SRND.S:START. The status line will show that the emulator is "Running user program".

When entering the name of a local symbol for the first time, you need to include the module name. This causes that module to become the default module, and the next time you refer to a symbol from that module, you do not have to include the module name.

Activating the Trace Window

The examples which follow show results in the "zoomed" trace window. To activate this window, select:

Window, Zoom

Then either type in, or use the **Tab** key to select "Analysis", and press **Enter**.

Specifying a Simple Trigger

Suppose you want to look at the execution of the sample program after the AGAIN address, but only after it has occurred three times (in other words, after the program has executed its complete loop three times). To do this, select:

Analysis, **T**race, **M**odify

Modify the trace specification as shown in figure 3-4. (To access the "patterns and expressions" screen, press the **Enter** key while the cursor is in the "trigger on" field.)

Notice that the address symbol AGAIN is assigned to pattern "a" and an occurrence count of "3" is specified.

To save the new specification, use the **Enter** key to exit out of the field in the lower right corner.

```
Internal State Trace Specification
1 While storing any state
  Trigger on a 3 times

2 Store any state

Branches off      Count time      Prestore off      Trigger position
start of 512

STATUS: M68000--Running user program      Emulation trace complete

Use the TAB and Shift-TAB keys to select a trigger position or enter a number.
```

Figure 3-4. Simple Trigger Specification

Internal State Trace Specification

Range (r)	Label	Set 1	thru	stat
Pat	addr	addr	data	stat
a	=	AGAIN		
b	=			
c	=			
d	=			
Set 2				
e	=			
f	=			
g	=			
h	=			
arm	=			
Expression				
Expressions have the form: <set1> and/or <set2>. Where set1 consists of <a, b, c, d, r, !r> and set2 consists of <e, f, g, h, arm>. Patterns within a set can be joined with !(or) or ~(nor), but not both. Example: !r ~ a or e f g h				
Pattern Expression: a				

STATUS: M68000--Running user program Emulation trace complete

TAB selects a simple pattern or enter an expression or move up to edit patterns.

Figure 3-4. Simple Trigger Specification (Cont'd)

To begin the trace, select:

Analysis, Begin

After the "Trace complete" message is shown on the status line, display the trace by selecting:

Analysis, Display

Type the first state that can be displayed into the starting state field and press **Enter**. Move the cursor to the ending state field, enter the starting state plus 15, and press **Enter**. The resulting trace is similar to the trace shown in the following display.

Analysis					
Line	addr,H	68000 Mnemonic,H		count,R	seq
0	00040a	MOVEA.L D1,A1		---	+
1	00040c	MOVE.L D0,D1		0.520 uS	.
2	00040e	BSR.W 000046a		0.480 uS	.
3	000410	005a	supr prog	0.520 uS	.
4	000bfa	0000	supr data wr word	0.720 uS	.
5	000bfc	0412	supr data wr word	0.520 uS	.
6	00046a	MOVE.L 0000600,D0		0.480 uS	.
7	00046c	0000	supr prog	0.520 uS	.
8	00046e	0600	supr prog	0.480 uS	.
9	000470	MULS.W #04e6d,D0		0.520 uS	.
10	000600	2284	supr data rd word	0.480 uS	.
11	000602	1608	supr data rd word	0.520 uS	.
12	000472	4e6d	supr prog	0.480 uS	.
13	000474	MOVEA.L D0,A0		0.520 uS	.
14	000476	LEA.L 00339[A0],A0		0.480 uS	.
15	000478	0339	supr prog	7.280 uS	.

STATUS: M68000--Running user program Emulation trace complete
Window System Register Processor Breakpoints Memory Config Analysis
Begin Halt CMB Format Trace Display

In the trace list above, line 0 shows the beginning of the program loop and line 2 shows the call of the RAND subroutine. The disassembled mnemonics on line 6 shows the first instruction executed in the RAND subroutine.

To display more lines of the trace, select:

Analysis Display

Notice that the starting and ending lines are incremented by the number of lines given in the last display command. Press **Enter** two times to select these values.

Analysis					
Line	addr,H	68000 Mnemonic,H		count,R	seq
16	00047a	MOVE.L	A0,D0	0.480 uS	.
17	00047c	MOVE.L	D0,0000600	0.520 uS	.
18	00047e	0000	supr prog	0.480 uS	.
19	000480	0600	supr prog	0.520 uS	.
20	000482	CLR.W	D0	0.480 uS	.
21	000600	06bf	supr data wr word	0.520 uS	.
22	000602	d4a1	supr data wr word	0.480 uS	.
23	000484	SWAP.W	D0	0.520 uS	.
24	000486	ANDI.L	#000000ff,D0	0.480 uS	.
25	000488	0000	supr prog	0.520 uS	.
26	00048a	00ff	supr prog	0.480 uS	.
27	00048c	RTS		0.520 uS	.
28	00048e	1340	unused prefetch	0.480 uS	.
29	000bfa	0000	supr data rd word	1.000 uS	.
30	000bfc	0412	supr data rd word	0.520 uS	.
31	000412	BTST.L	#01,D1	0.480 uS	.

STATUS: M68000--Running user program Emulation trace complete
Window System Register Processor Breakpoints Memory Config Analysis
Begin Halt CMB Format Trace Display

In the display above, you see remaining execution of the instructions in the RAND subroutine. To display more lines in the trace, press **CTRL-R** to repeat the previous command. Since you pressed **Enter** in the previous command to select the automatically incremented starting and ending line numbers, the automatically incremented line numbers are selected again, and the next 16 lines of the trace are displayed.

```

Analysis
-----
Line  addr,H  68000 Mnemonic,H  count,R  seq
-----
32  000414  ORI.B  #000,D1  0.520 uS  .
33  000416      6700  supr prog  0.480 uS  .
34  000418  ORI.B  #**,D4  0.520 uS  .
35  00041c  BTST.L #00,D1  1.000 uS  .
36  00041e      0000  supr prog  0.480 uS  .
37  000420  BEQ.W  0000430  0.520 uS  .
38  000422      000e  supr prog  0.480 uS  .
39  000430  BSR.W  000048e  1.000 uS  .
40  000432      005c  supr prog  0.520 uS  .
41  000bfa      0000  supr data wr word  0.720 uS  .
42  000bfc      0434  supr data wr word  0.520 uS  .
43  00048e  MOVE.B D0,00500[A1]  0.480 uS  .
44  000490      0500  supr prog  0.520 uS  .
45  000492  RTS  0.480 uS  .
46  000583      bf  supr data wr byte  0.520 uS  .
47  000494  MOVEA.L ***[A7],A1  0.480 uS  .

STATUS: M68000--Running user program      Emulation trace complete
Window System Register Processor Breakpoints Memory Config Analysis
Begin Halt CMB Format Trace Display

```

In the trace list above you see the instructions that write the random number to the RESULTS area.

Using Storage Qualifiers

In the last example, all captured states were stored. To modify the trace specification of the previous example so that only the states which write random numbers to the RESULTS area are stored, select:

Analysis, Trace, Modify

Modify the trace specification as shown in figure 3-5.

To begin the trace, select:

Analysis, Begin

Internal State Trace Specification

1 While storing any state
 Trigger on a [redacted] 3 times

2 Store [redacted]

Branches off [redacted] Count time [redacted] Prestore off [redacted] Trigger position start [redacted] of 512

STATUS: M68000--Running user program Emulation trace complete

Use the TAB and Shift-TAB keys to select a trigger position or enter a number.

Internal State Trace Specification

Range (r)	Label	addr	=	Set 1	RESULTS thru	RESULTS+0ff
Pat		addr			data	stat
a =				AGAIN		
b =						
c =						
d =						
Set 2						
e =						
f =						
g =						
h =						
arm						

Expression

Expressions have the form: <set1> and/or <set2>. Where set1 consists of <a, b,c,d,r,!r> and set2 consists of <e,f,g,h,arm>. Patterns within a set can be joined with !(or) or ~(nor), but not both. Example: !r ~ a or e | f | g | h

Pattern Expression: r [redacted]

STATUS: M68000--Running user program Emulation trace complete

TAB selects a simple pattern or enter an expression or move up to edit patterns.

Figure 3-5. Storage Qualifier Specification

After the "Trace complete" message is shown on the status line, display the trace by selecting:

Analysis, Display

Type the number of the starting state plus 15 into the ending state field, and press **Enter**. The resulting trace will be similar to the display shown below.

Line	addr,H	68000 Mnemonic,H	count,R	seq
0	00040a	MOVEA.L D1,A1	---	+
1	0005ce	fe supr data wr byte	34.76 uS	.
2	0005fb	9f supr data wr byte	37.48 uS	.
3	0005fe	85 supr data wr byte	40.24 uS	.
4	00059f	de supr data wr byte	37.52 uS	.
5	000585	c2 supr data wr byte	38.76 uS	.
6	0005de	b6 supr data wr byte	38.72 uS	.
7	0005c2	84 supr data wr byte	38.76 uS	.
8	0005b6	00 supr data wr byte	37.24 uS	.
9	000584	63 supr data wr byte	37.28 uS	.
10	000500	ad supr data wr byte	40.24 uS	.
11	000563	16 supr data wr byte	37.48 uS	.
12	0005ad	5e supr data wr byte	38.76 uS	.
13	000516	f1 supr data wr byte	38.76 uS	.
14	00055e	e9 supr data wr byte	38.76 uS	.
15	0005f1	80 supr data wr byte	38.72 uS	.

STATUS: M68000--Running user program Emulation trace complete

Window System Register Processor Breakpoints Memory Config Analysis

Begin Halt CMB Format Trace Display

Notice that the trigger state (line 0) is included in the trace list; trigger states are always stored.

This trace shows that the last two hex digits of the address in the RESULTS area are the same as the random number which gets written two states earlier (see the data in the "mnemonic" column of the trace list). This is expected because the sample program writes the current random number using the second previous random number as an offset into the RESULTS area.

Using Trace Prestore

Prestore lets you to save up to two states which precede a normal store state. The following example uses a prestore qualifier to show which caller of WRITE_NUMBER corresponds to each value written to the RESULTS area. Because you know the BSR assembly language instruction is used to call a subroutine, you can qualify prestore states as states whose data equals the BSR opcode (6100H). First of all, select:

Analysis, Trace, Modify

Modify the trace specification as shown in figure 3-6.

```
Internal State Trace Specification
1 While storing any state
  Trigger on a [redacted] 3 times

2 Store [redacted]

Branches off [redacted]   Count time   Prestore on [redacted]   Trigger position
                                                                start of 512

STATUS: M68000--Running user program           Emulation trace complete

Use the TAB and Shift-TAB keys to select a trigger position or enter a number.
```

Figure 3-6. Prestore Qualifier Specification

Internal State Trace Specification

Range (r)	Label	addr	=	Set 1	RESULTS thru	RESULTS+0ff
Pat		addr			data	stat
a	=			AGAIN		
b	=				6100	
c	=					
d	=					
				Set 2		
e	=					
f	=					
g	=					
h	=					
arm	=					
Expression						
Expressions have the form: <set1> and/or <set2>. Where set1 consists of <a, b,c,d,r,?r> and set2 consists of <e,f,g,h,arm>. Patterns within a set can be joined with !(or) or ~(nor), but not both. Example: ?r ~ a or e ! f ! g ! h						
Pattern Expression: b						

STATUS: M68000--Running user program Emulation trace complete

TAB selects a simple pattern or enter an expression or move up to edit patterns.

Figure 3-6. Prestore Qualifier Specification (Cont'd)

To begin the trace, select:

Analysis, Begin

After the "Trace complete" message is shown on the status line, display the trace by selecting:

Analysis, Display

Type the number of the starting state plus 15 into the ending state field, and press **Enter**. The resulting trace will be similar to the display which follows.

Analysis				
Line	addr,H	68000 Mnemonic,H	count,R	seq
0	00040a	MOVEA.L D1,A1	---	+
1	00040e	BSR.W*****	prestore	.
2	00043c	BSR.W*****	prestore	.
3	000548	ad supr data wr byte	33.28 uS	.
4	00040e	BSR.W*****	prestore	.
5	000436	BSR.W*****	prestore	.
6	0005d2	73 supr data wr byte	38.72 uS	.
7	000430	BSR.W*****	prestore	.
8	000442	BSR.W*****	prestore	.
9	0005ad	c5 supr data wr byte	40.28 uS	.
10	00040e	BSR.W*****	prestore	.
11	000436	BSR.W*****	prestore	.
12	000573	d8 supr data wr byte	37.48 uS	.
13	00040e	BSR.W*****	prestore	.
14	000430	BSR.W*****	prestore	.
15	0005c5	b7 supr data wr byte	37.24 uS	.

STATUS: M68000--Running user program Emulation trace complete
Window System Register Processor Breakpoints Memory Config Analysis
Begin Halt CMB Format Trace Display

The prestore state immediately preceding each write state shows the address of the caller.

The analyzer uses the same resource to save prestore states as it does to save count tags. Consequently, the "prestore" string is shown in the "count" column of the trace list. Note that the time counts are relative to the previous normal storage state. Turning off the count qualifier does not turn off prestore; however, the "prestore" string cannot be seen in the "count" column of the trace list.

States which satisfy the prestore qualifier and the storage qualifier at the same time are stored as normal states.

Changing the Count Qualifier

Suppose now that you are interested in only one address in the RESULTS area, say 5C2H. You wish to see how many loops of the program occur between each write of a random number to this address. You can set up the trace specification so that only writes to address 5C2H are stored; then, you can specify as a count qualifier a state which occurs once on each loop of the program. First of all, select:

Analysis, Trace, Modify

Modify the trace specification as shown in figure 3-7.

```
Internal State Trace Specification
1 While storing any state
  Trigger on a [redacted] 3 times

2 Store [redacted]

Branches off [redacted]   Count state [redacted]   Prestore off [redacted]   Trigger position
                                                                start of 512

STATUS: M68000--Running user program           Emulation trace complete

Use the TAB and Shift-TAB keys to select a trigger position or enter a number.
```

Figure 3-7. Count Qualifier Specification

Internal State Trace Specification

Range (r)	Label	addr	=	Set 1	thru	stat
Pat		addr			data	
a	=			AGAIN		
b	=			5c2		write
c	=					
d	=					
Set 2						
e	=					
f	=					
g	=					
h	=					
arm	=					
Expression						
Expressions have the form: <set1> and/or <set2>. Where set1 consists of <a, b,c,d,r,?r> and set2 consists of <e,f,g,h,arm>. Patterns within a set can be joined with !(or) or ~(nor), but not both. Example: ?r ~ a or e ! f ! g ! h						
Pattern Expression: b						

STATUS: M68000--Running user program Emulation trace complete

TAB selects a simple pattern or enter an expression or move up to edit patterns.

Figure 3-7. Count Qualifier Specification (Cont'd)

To begin the trace, select:

Analysis, Begin

After the "Trace complete" message is shown on the status line, display the trace by selecting:

Analysis, Display

Type the number of the starting state plus 15 into the ending state field, and press **Enter**. The resulting trace display will be similar to the display which follows.

Analysis						
Line	addr,H	68000 Mnemonic,H			count,R	seq
0	00040a	MOVEA.L D1,A1			---	+
1	0005c2	4c	supr data wr byte		341	.
2	0005c2	40	supr data wr byte		51	.
3	0005c2	12	supr data wr byte		12	.
4	0005c2	45	supr data wr byte		655	.
5	0005c2	19	supr data wr byte		0	.
6	0005c2	3f	supr data wr byte		0	.
7	0005c2	3f	supr data wr byte		0	.
8	0005c2	10	supr data wr byte		1	.
9	0005c2	ee	supr data wr byte		49	.
10	0005c2	e1	supr data wr byte		409	.
11	0005c2	85	supr data wr byte		472	.
12	0005c2	60	supr data wr byte		183	.
13	0005c2	2c	supr data wr byte		38	.
14	0005c2	40	supr data wr byte		0	.
15	0005c2	54	supr data wr byte		0	.

STATUS: M68000--Running user program Emulation trace complete
Window System Register Processor Breakpoints Memory Config Analysis
Begin Halt CMB Format Trace Display

The trace listing above shows that the program executes a variable number of times for each time that a random number is written to 5C2H. Where counts of 0 are seen, the sample program is executing in the QSORT routine which sorts the values written to the RESULTS area.

Using "Restart On" Branches

Selecting "restart on" branches is useful in some situations to trace a specific combination of events. For example, CALLER_3 can be used to write any random number, but suppose you want to trace only the situation where CALLER_3 is used to write a random number to address 5C2H. You can set up the sequence levels so that the analyzer first searches for CALLER_3.

After CALLER_3 is found, the sequencer should then search for the write to address 5C2H.

However, if the program jumps to AGAIN or calls QSORT before the write to 5C2H, you know that CALLER_3 is not used to write the random number this time, and the analyzer should start searching again from the beginning.

If the write to address 5C2H occurs before the program executes the instruction at AGAIN or some instruction in the QSORT routine, the analyzer will trigger.

To make this specification, select:

Analysis, **T**race, **M**odify

Modify the trace specification as shown in figure 3-8.

Internal State Trace Specification

1 While storing any state
Find c 1 times

2 While storing any state
Trigger on b 1 times

3 Store any state

Branches restart on a ! d Count time Prestore off Trigger position center of 512

STATUS: M68000--Running user program Emulation trace complete

Use the TAB and Shift-TAB keys to select a trigger position or enter a number.

Internal State Trace Specification

Range (r)	Label	addr	=	Set 1	thru	data	stat
a =				AGAIN			
b =				5c2			write
c =				CALLER_3			
d =				INC_LOW			
Set 2							
e =							
f =							
g =							
h =							
arm							
Expression							
Expressions have the form: <set1> and/or <set2>. Where set1 consists of <a, b,c,d,r,!r> and set2 consists of <e,f,g,h,arm>. Patterns within a set can be joined with !(or) or ~(nor), but not both. Example: !r ~ a or e ! f ! g ! h							
Pattern Expression: a ! d							

STATUS: M68000--Running user program Emulation trace complete

TAB selects a simple pattern or enter an expression or move up to edit patterns.

Figure 3-8. Branches "Restart On" Specification

To begin the trace, select:

Analysis, Begin

After the "Trace complete" message is shown on the status line, display the trace by selecting:

Analysis, Display

Type -7 into the starting state field and 8 into the ending state field, and press **Enter**. The resulting trace will be similar to the display which follows.

Line	addr,H	68000 Mnemonic,H	count,R	seq
-7	000442	BSR.W 000048e	0.760 uS	+
-6	000444	004a supr prog	0.520 uS	.
-5	000bfa	0000 supr data wr word	0.720 uS	.
-4	000bfc	0446 supr data wr word	0.520 uS	.
-3	00048e	MOVE.B D0,00500[A1]	0.480 uS	.
-2	000490	0500 supr prog	0.520 uS	.
-1	000492	RTS	0.480 uS	.
0	0005c2	1a supr data wr byte	0.520 uS	+
1	000494	MOVEA.L ***[A7],A1	0.480 uS	.
2	000bfa	0000 supr data rd word	0.520 uS	.
3	000bfc	0446 supr data rd word	0.480 uS	.
4	000446	CMPI.W #00000,D2	0.520 uS	.
5	000448	0000 supr prog	0.480 uS	.
6	00044a	DBEQ D2,000040a	0.520 uS	.
7	00044c	ffbe supr prog	0.480 uS	.
8	00040a	MOVEA.L D1,A1	0.760 uS	+

STATUS: M68000--Running user program Emulation trace complete

Window System Register Processor Breakpoints Memory Config **Analysis**

Begin Halt CMB Format Trace Display

Using Branches "Per Level"

Selecting branches "per level" in the trace specification gives you access to the full power and flexibility of the analyzer. Branches per level are used when you need to trace more complicated conditions.

There is a "bug" in this chapter's sample program. Occasionally, after the 256 bytes of the RESULTS area have been sorted by the QSORT subroutine, you will see a byte out of order in the last eight or so bytes of the area. You can see what happens by setting software breakpoints before and after the QSORT routine is executed, running the program, and displaying memory.

First of all, break to the monitor by selecting:

Processor, **B**reak

Now, define a keystroke sequence macro which will:

- Set a breakpoint at the beginning of the QSORT subroutine.
- Run the program until that breakpoint is hit (so you know the contents in the RESULTS area are about to be sorted).
- Set another breakpoint at the AGAIN address.
- Run the program until the AGAIN address is hit (the contents of the RESULTS area should be sorted at this point).
- Display the contents of the results area.

To enter a keystroke macro, select:

Config, **K**ey_Macro

The cursor is now in the field which defines the key that executes the keystroke macro. Use the **Tab** key to select F3. Leave **ESC** as the key used to quit the keystroke sequence, and position the cursor to the keystroke sequence field and type:

bssQSORT

and press **Enter**. Now type:

pgpbssAGAIN

and press **Enter**. Continue typing:

pgpmdbRESULTS..RESULTS+0f fh

and press **Enter**. Terminate the keystroke macro by pressing **ESC**.

Before executing the F3 keystroke macro, define breakpoints at QSORT and AGAIN by selecting:

Breakpoints, Add

Type in "QSORT;AGAIN" into the breakpoint addresses field, and press **Enter**. When you add breakpoints, they are also set. Because breakpoints should be cleared when you execute the keystroke macro, select:

Breakpoints, Clear, All

Now, execute the keystroke macro by pressing F3, and press **CTRL-Z** to zoom the emulation memory display window.

Emulation																	
Address	Data (hex)													Ascii			
0000500	80	82	82	83	85	86	89	8a	8c	8c	8f	8f	8f	91	92	92
0000510	92	92	97	97	99	9b	9c	9d	9f	9f	9f	a1	a1	a2	a4	a5
0000520	a5	a6	a7	a9	ab	ac	ac	ac	ae	af	af	b0	b3	b3	b3	b3
0000530	b4	b4	b5	b6	b8	b9	bb	bf	c2	c2	c3	c3	c3	c5	c5	c6
0000540	c7	c7	c7	c9	ca	cc	cd	cd	cf	d2	d2	d3	d6	d6	d7	d7
0000550	d8	da	db	dc	dc	dd	dd	e0	e0	e1	e1	e2	e3	e3	e4	e4
0000560	e6	e8	e8	e8	e9	e9	ee	f0	f3	f3	f4	f4	f4	f6	f8	f8
0000570	fa	fd	fe	00	01	03	03	04	04	05	06	07	07	08	09	0a
0000580	0a	0c	0e	13	14	14	15	15	16	17	18	19	19	1a	1b	1b
0000590	1c	1d	1e	1e	1f	20	21	21	22	22	23	23	23	24	25	25
00005a0	26	27	27	29	2a	2c	2f	2f	30	31	31	31	31	35	37	39
00005b0	39	3a	3b	3b	3b	3c	3c	3c	3c	3c	3c	3d	3d	3f	40	40
00005c0	41	41	43	44	44	46	46	47	49	49	4a	4b	4c	4e	4e	4e
00005d0	4f	52	52	53	54	54	54	56	56	56	58	5b	5b	5d	5e	5e
00005e0	5e	5f	61	61	61	62	62	63	64	66	66	68	68	69	6e	6e
00005f0	70	72	73	76	77	77	77	78	79	79	79	7a	7a	7c	17	7e

STATUS: M68000--Running in monitor Emulation trace complete
Window System Register Processor Breakpoints Memory Config Analysis
Display Modify Load Store Copy Find Report

Look carefully at the last several bytes of the RESULTS area. You may notice that a byte is out of order. If not, press F3 and look at the

3-28 Examples

display again. Sometimes, the program seems to work correctly; other times, you will see a byte out of order.

The memory display shows that the QSORT routine works for the most part, which makes it look like the problem occurs on the final write to the RESULTS area. To verify this, set up the sequencer to trigger on any event, store only the address following the return from QSORT (to the main program), and prestore writes to the last eight bytes of the RESULTS area. To do this, modify the trace specification by selecting:

Analysis, Trace, Modify

Modify the trace specification as shown in figure 3-9.

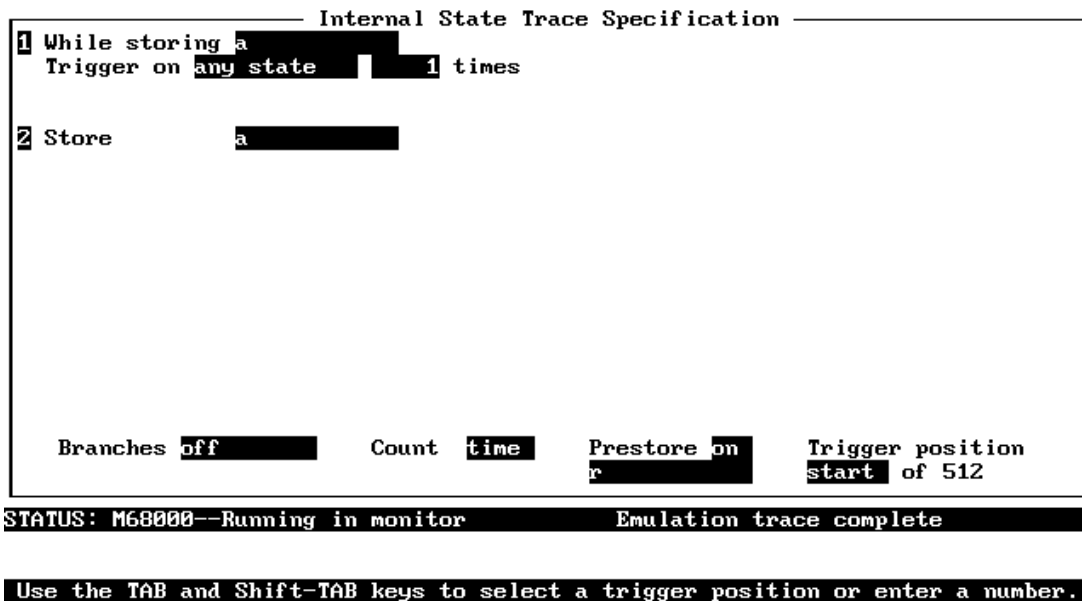

Figure 3-9. Tracing Last Write to RESULTS Area

Internal State Trace Specification

Range (r)	Label	addr	=	Set 1	RESULTS+0f8 thru	RESULTS+0ff
Pat		addr			data	stat
a =						
b =						
c =						
d =						
				Set 2		
e =						
f =						
g =						
h =						
arm						
Expression						
Expressions have the form: <set1> and/or <set2>. Where set1 consists of <a, b, c, d, r, !r> and set2 consists of <e, f, g, h, arm>. Patterns within a set can be joined with !(or) or ~(nor), but not both. Example: !r ~ a or e ! f ! g ! h						
Pattern Expression: r						

STATUS: M68000--Running in monitor **Emulation trace complete**

TAB selects a simple pattern or enter an expression or move up to edit patterns.

Figure 3-9. Tracing Last Write to RESULTS (Cont'd)

To begin the trace, select:

Processor, **G**o, **P**c
Analysis, **B**egin

After the "Trace complete" message is shown on the status line, display the trace by selecting the following commands:

Window, **Z**oom

Use the **Tab** key to select the "Analysis" window, and press **Enter**.
Now to display the trace, select:

Analysis, **D**isplay

Enter the first state to display in the starting state field, and the starting state plus 15 into the ending state field, and press **Enter**. The display will be similar to the following display.

Line	addr,H	68000 Mnemonic,H	count,R	seq
0	00048c	RTS	---	+
1	0005fe	1e	supr data wr byte	prestore .
2	0005fe	1e	supr data wr byte	prestore .
3	000462	ADDA.L	#####,A7	53.39 mS .
4	0005fe	e0	supr data wr byte	prestore .
5	0005fe	e0	supr data wr byte	prestore .
6	000462	ADDA.L	#####,A7	60.17 mS .
7	0005fd	7d	supr data wr byte	prestore .
8	0005fe	7d	supr data wr byte	prestore .
9	000462	ADDA.L	#####,A7	67.48 mS .
10	0005fe	7e	supr data wr byte	prestore .
11	0005fe	7e	supr data wr byte	prestore .
12	000462	ADDA.L	#####,A7	64.10 mS .
13	0005fc	7c	supr data wr byte	prestore .
14	0005fc	7c	supr data wr byte	prestore .
15	000462	ADDA.L	#####,A7	65.99 mS .

STATUS: M68000--Running user program Emulation trace complete
Window System Register Processor Breakpoints Memory Config Analysis
Begin Halt CMB Format Trace Display

From the previous trace, you see that the final writes made in the QSORT subroutine are indeed improper values for that part of the RESULTS area. Displaying additional lines of the trace shows you that it is common for bad values to be written to 5FEH. You can set up a trace to trigger on one of the bad writes to 5FEH, and store all the states which lead up to this event. The resulting trace may show you what is wrong with the program.

The sequencer specification which follows will trigger on a write of any value from 80H through 0FFH to 5FEH. The sequencer algorithm to capture the events which lead to a final QSORT write of an inappropriate value to 5FEH is listed below.

1. Search for the beginning of the QSORT routine. (The first occurrence of the INC_LOW address assures that the QSORT routine is actually entered; this eliminates prefetches of the QSORT address from being interpreted as entry into the routine.)

- 
2. If a write of an inappropriate value (80H through 0FFH) to address 5FEH occurs, this may or may not be the trigger event -- another condition must be tested (see 3). Else, if the QSORT routine exits before a write of a bad value to 5FEH occurs, the trigger event has not occurred in this loop of the program; in this case, the sequencer should restart.
 3. A write of an inappropriate value to 5FEH has occurred. If the QSORT routine exits without any other value being written to 5FEH, this is the trigger event. Else, if a write of some other value other is made to 5FEH, the previous write is not the event to trigger on, and the sequencer should go back to searching for writes of bad values to 5FEH.

To set up this trace specification, select:

Analysis, **T**race, **M**odify

Modify the trace specification as shown in figure 3-10.

Notice that the range of data values are from 8000H through 0FFFFH. Byte values are written to 5FEH, and they are written on the upper 8 bits of the bus. It doesn't matter what value is on the lower 8 bits of the bus, but don't cares are not allowed in values assigned to the range resource.

Notice also that the trigger position is changed to 502 of 512.

```

Internal State Trace Specification
1 While storing no state
  Find a 1 times
  Else on no state go to level 1
2 While storing any state
  Then find e and r 1 times
  Else on b go to level 1
3 While storing any state
  Trigger on b 1 times
  Else on e and !r go to level 2
4 While storing no state
  Then find any state 1 times
  go to level 1

Branches per level Count time Prestore off Trigger position
502 of 512

```

STATUS: M68000--Running user program Emulation trace complete

Use the TAB and Shift-TAB keys to select a trigger position or enter a number.

```

Internal State Trace Specification
Range (r) Label data = 8000 thru 0fff
Pat addr data stat
a = INC_LOW
b = 462
c =
d =
Set 2
e = 5fe
f =
g =
h =
arm
Expression
Expressions have the form: <set1> and/or <set2>. Where set1 consists of <a,
b,c,d,r,!r> and set2 consists of <e,f,g,h,arm>. Patterns within a set can be
joined with !(or) or ~(nor), but not both. Example: !r ~ a or e ! f ! g ! h
Pattern Expression: e and !r

```

STATUS: M68000--Running user program Emulation trace complete

TAB selects a simple pattern or enter an expression or move up to edit patterns.

Figure 3-10. Branches "Per Level" Specification

To begin the trace, select:

Analysis, Begin

After the "Trace complete" message is shown on the status line, display the trace by selecting:

Analysis, Display

Display all the lines in the trace. After the trace is displayed, use the **PgUp** to find the sequence branch prior to the trigger.

```
Analysis
-200 0004a6 ADDQ.L #1,A0          0.720 uS .
-199 0004a8 CMP.B [A0],D2         0.520 uS .
-198 0004aa BLE.W 00004b6        0.480 uS .
-197 000601      56  supr data rd byte  1.000 uS .
-196 0004ac      000a supr prog        0.520 uS .
-195 0004ae CMPA.L A0,A1         1.000 uS .
-194 0004b0 BLT.W 00004ca        0.480 uS .
-193 0004b2      0018 supr prog        0.520 uS .
-192 0004ca MOVEA.L 00004[A7],A0  1.000 uS .
-191 0004cc      0004 supr prog        0.480 uS .
-190 0004ce MOVE.B [A1],[A0]     0.520 uS .
-189 000bc6      0000 supr data rd word  0.480 uS .
-188 000bc8      05fe supr data rd word  0.520 uS .
-187 0004d0 MOVE.B D2,[A1]       0.480 uS .
-186 000600      f7  supr data rd byte  0.520 uS .
-185 0005fe      f7  supr data wr byte  0.480 uS +
-184 0004d2 MOVE.L 00008[A7],[-A7] 0.520 uS .
-183 000600      7f  supr data wr byte  0.480 uS .
-182 0004d4      0008 supr prog        0.520 uS .

STATUS: M68000--Running user program      Emulation trace complete
Window System Register Processor Breakpoints Memory Config Analysis
Begin Halt CMB Format Trace Display
```

From the trace display above, you can see that the instructions at addresses 4CAH and 4CEH are the ones that cause the problems. These are the instructions associated with the OUT section of the QSORT subroutine. They are used to swap the dividing value and the value at the high index after a segment of the list to be sorted is split. You can see that the high index is address 600H, which it should never be.

Looking back at the program you see that the increment of the high index so that DEC_HIGH works the first time through will cause problems when the BLT OUT instruction gets executed in the

INC_LOW loop. Changing the program in the following manner will fix the problem (notice the instructions surrounded by the "#" character).

```

*****
* The QSORT subroutine is passed (on the stack)
* the high and low addresses of an area of bytes
* to be sorted.
*****
QSORT      MOVE.L  8[A7],A1 ; A1 = high index.
           MOVE.L  4[A7],A0 ; A0 = low index.
;-----
; The following section splits the area to be sorted
; into two areas.  QSORT will be called to sort each
; of these smaller areas.
;
; If high index is less than low index, then sort
; is done.
;-----
OVER      CMPA.L  A0,A1
           BLE     DONE
;-----
; D2 = dividing value (from low index).
;-----
           MOVE.B  [A0],D2
;-----
; (Increment allows DEC_HIGH loop to work first
; time through.)
;-----
;#### The following instruction is deleted. ####
;
;      ADDQ.L  #1,A1
;#####
;
; Move low index up until it points to a value
; greater than the dividing value.
;-----
INC_LOW   ADDQ.L  #1,A0
           CMP.B  [A0],D2
;#### The following instruction is changed. ####
;
;      BLE     DEC_HIGH
;#####
;
;      BLE     NEXT
;      CMPA.L  A0,A1
;      BLT     OUT
;      BRA.B  INC_LOW
;#### The following instruction is new. ####
NEXT      ADDQ.L  #1,A1
;#####
;
; Move high index down until it points to a value
; less than or equal to the dividing value.
;-----
DEC_HIGH  SUBQ.L  #1,A1
           CMP.B  [A1],D2
           BLT     DEC_HIGH
;-----
; If high index is less than or equal to low index,
; the area is split; do not swap values.
;-----
           CMPA.L  A0,A1
           BLT     OUT

```



```

;-----
; If high index is greater than low index, swap
; values and move indexes again.
;-----
        MOVE.B  [A0],D3
        MOVE.B  [A1],[A0]
        MOVE.B  D3,[A1]
        BRA.B   INC_LOW
;-----
; A0 = low address (needed to swap dividing value).
;-----
OUT      MOVE.L  4[A7],A0
;-----
; Swap dividing value and high index value.
;-----
        MOVE.B  [A1],[A0]
        MOVE.B  D2,[A1]
;-----
; The area is now split into two smaller areas.
; The last high index value is the middle of the
; two areas. The high and low addresses for the
; second QSORT call are pushed first.
;-----
        MOVE.L  8[A7],[-[A7]] ; Push high.
        ADDQ.L  #1,A1
        MOVE.L  A1,-[A7] ; Push middle + 1.
        SUBQ.L  #2,A1
        MOVE.L  A1,-[A7] ; Push middle - 1.
        MOVE.L  A0,-[A7] ; Push low.
        BSR.W   QSORT
;-----
; Increment stack pointer after call.
;-----
        ADDA.L  #8,A7
        BSR.W   QSORT
        ADDA.L  #8,A7
DONE      RTS

```

Storing "Windows" of Program Execution

One common use for branches "per level" is to trace "windows" of execution. If you're only interested in the execution that occurs between two instructions, you may not want the trace to contain states that occur before and after.

Sequence levels are paired in a typical windowing trace specification. The first sequence level searches for the window enable state, and no states are stored while searching. When the window enable state is

3-36 Examples

found, the analyzer proceeds to the second sequence level which stores the states you're interested in while searching for the window disable state.

If you want to store the window before and after the trigger, use two sets of paired sequence levels: one window enable/disable pair of sequence terms before the trigger, and the another disable/enable pair after the trigger (see figure 3-11). Notice that the order of the second sequence level pair is swapped; if you find the trigger while searching for the window disable state, you want the analyzer to branch to a level that continues to search for the disable state.

For example, to trace only the execution of the sample program's RAND subroutine, you would set up the sequencer specification so that the execution of the first instruction in the RAND subroutine is the window enable state and the address of the RAND subroutine's "return" instruction is the window disable state. Suppose also that you wish to trigger on the INC_LOW instruction of the QSORT routine.

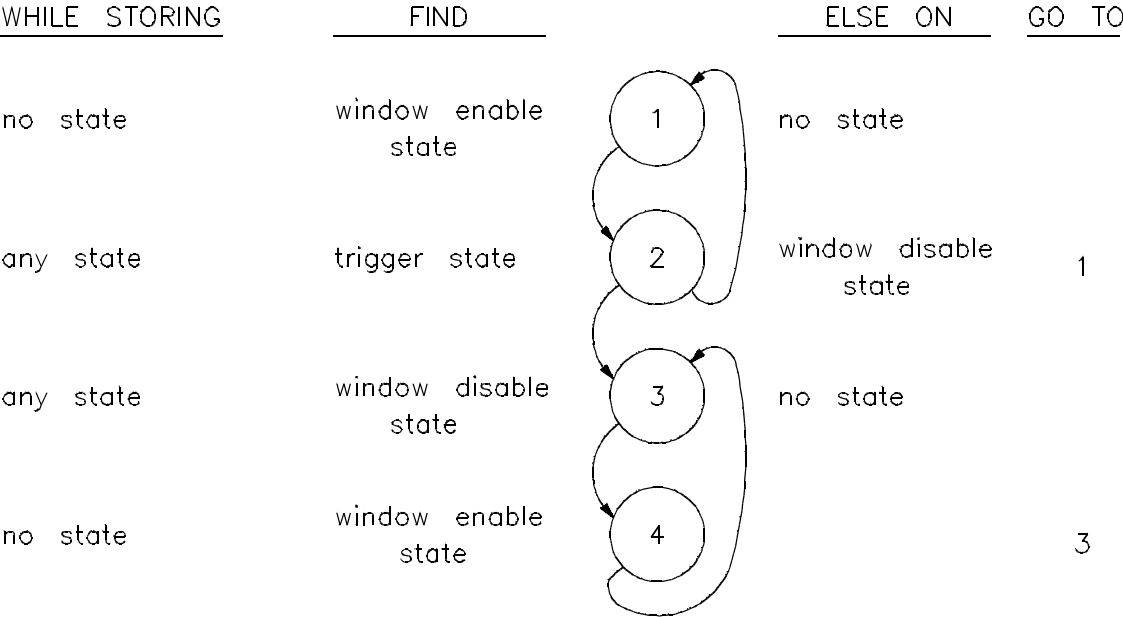

Figure 3-11. Storing a Window of Program Execution

To set up this trace specification, select:

Analysis, **T**race, **M**odify

Modify the trace specification as shown in figure 3-12.

```
Internal State Trace Specification
1 While storing no state
  Find e 1 times
  Else on no state go to level 1
2 While storing any state
  Trigger on a 1 times
  Else on 1 go to level 1
3 While storing any state
  Then find d 1 times
  Else on no state go to level 1
4 While storing no state
  Then find e 1 times
  go to level 3

Branches per level Count time Prestore off Trigger position
center of 512

STATUS: M68000--Running user program Emulation trace complete

Use the TAB and Shift-TAB keys to select a trigger position or enter a number.
```

Figure 3-12. Store "Window" Trace Specification

Internal State Trace Specification

Range (r)	Label	=	thru	stat
Set 1				
Pat		addr	data	
a	=			
b	=	RAND+0c		
c	=			
d	=	RAND+22		
Set 2				
e	=	RAND		
f	=			
g	=			
h	=			
arm	=			
Expression				
Expressions have the form: <set1> and/or <set2>. Where set1 consists of <a, b, c, d, r, !r> and set2 consists of <e, f, g, h, arm>. Patterns within a set can be joined with !(or) or ~(nor), but not both. Example: !r ~ a or e ! f ! g ! h				
Pattern Expression: e				

STATUS: M68000--Running user program Emulation trace complete

TAB selects a simple pattern or enter an expression or move up to edit patterns.

Figure 3-12. Store "Window" Trace Spec. (Cont'd)

To begin the trace, select:

Analysis, Begin

After the "Trace complete" message is shown on the status line, display the trace by selecting:

Analysis, Display

Enter -8 in the starting state field and 7 in the ending state field to display the following lines of the trace.

Analysis						
Line	addr,H	68000 Mnemonic,H		count,R	seq	
-8	00046a	MOVE.L	0000600,D0		---	+
-7	00046c	0000	supr prog	0.520	uS	.
-6	00046e	0600	supr prog	0.480	uS	.
-5	000470	MULS.W	#04e6d,D0	0.520	uS	.
-4	000600	16c5	supr data rd word	0.480	uS	.
-3	000602	40fd	supr data rd word	0.520	uS	.
-2	000472	4e6d	supr prog	0.480	uS	.
-1	000474	MOVEA.L	D0,A0	0.520	uS	.
0	000476	LEA.L	00339[A0],A0	0.480	uS	+
1	000478	0339	supr prog	7.240	uS	.
2	00047a	MOVE.L	A0,D0	0.520	uS	.
3	00047c	MOVE.L	D0,0000600	0.480	uS	.
4	00047e	0000	supr prog	0.520	uS	.
5	000480	0600	supr prog	0.480	uS	.
6	000482	CLR.W	D0	0.520	uS	.
7	000600	13e8	supr data wr word	0.480	uS	.

STATUS: M68000--Running user program Emulation trace complete
Window System Register Processor Breakpoints Memory Config Analysis
Begin Halt CMB Format Trace Display

Display more lines of the trace by selecting:

Analysis, Display

Press the Enter key twice to select the automatically incremented starting state and ending state numbers to display the following lines of the trace.

Analysis						
Line	addr,H	68000 Mnemonic,H		count,R	seq	
8	000602	c4f2	supr data wr word	0.520	uS	.
9	000484	SWAP.W	D0	0.480	uS	.
10	000486	ANDI.L	#000000ff,D0	0.520	uS	.
11	000488	0000	supr prog	0.480	uS	.
12	00048a	00ff	supr prog	0.520	uS	.
13	00048c	RTS		0.480	uS	+
14	00046a	MOVE.L	0000600,D0	21.52	uS	+
15	00046c	0000	supr prog	0.480	uS	.
16	00046e	0600	supr prog	0.520	uS	.
17	000470	MULS.W	#04e6d,D0	0.480	uS	.
18	000600	13e8	supr data rd word	0.520	uS	.
19	000602	c4f2	supr data rd word	0.480	uS	.
20	000472	4e6d	supr prog	0.520	uS	.
21	000474	MOVEA.L	D0,A0	0.480	uS	.
22	000476	LEA.L	00339[A0],A0	0.520	uS	.
23	000478	0339	supr prog	7.240	uS	.

STATUS: M68000--Running user program Emulation trace complete
Window System Register Processor Breakpoints Memory Config Analysis
Begin Halt CMB Format Trace Display

Excluding Windows of Program Execution

You can use the sequencer to exclude windows of program execution by switching the storage qualifiers on the enable and disable sequence levels (see figure 3-13). In other words, store the states you're interested in while searching for the enable state and do not store states while searching for the disable state.

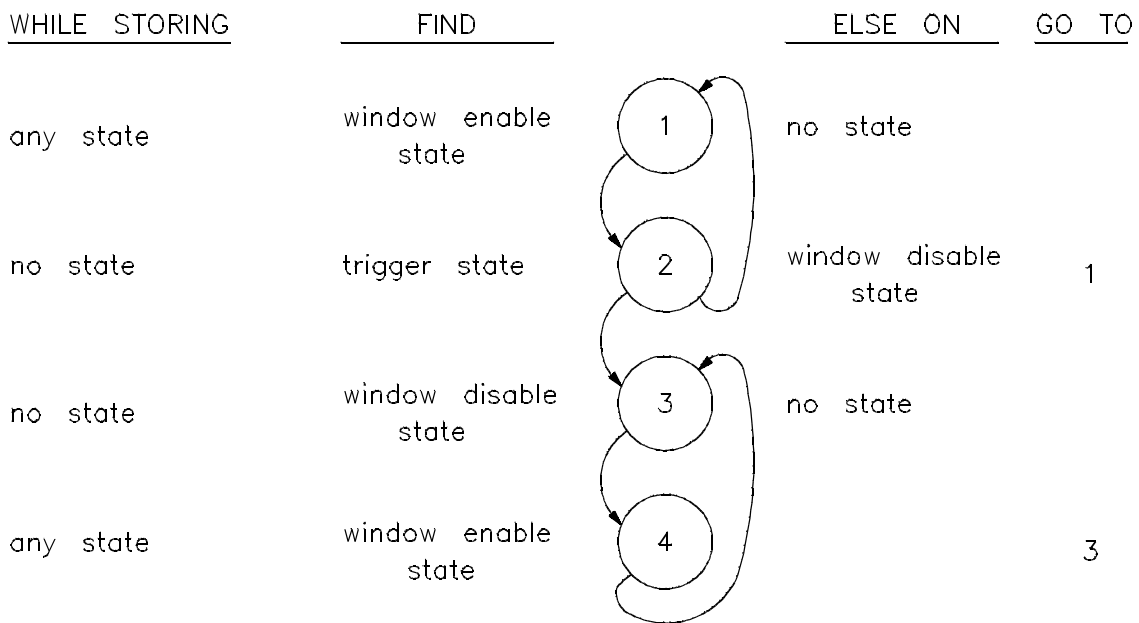

Figure 3-13. Excluding Windows of Program Execution

Triggering on a State Outside the Window

In the previous example, the trigger state occurred inside the window, between two sequence levels that searched for the window enable state. You can set up a trace specification that triggers on a state outside the window by having the trigger occur between two sequence levels that search for the window enable state as shown in figure 3-14.

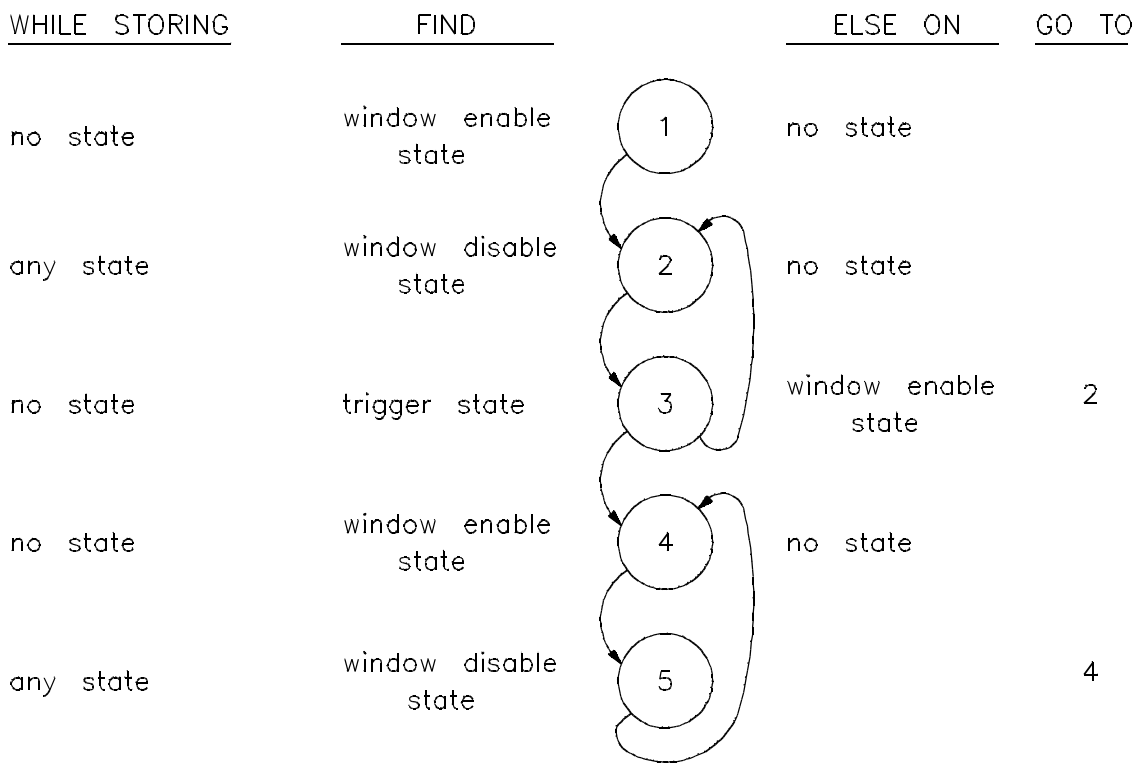

Figure 3-14. Triggering on a State Outside the Window

Using Multiple Trigger Levels

It is possible for the analyzer to trigger when finding a state in any sequence level but the last because **the trigger point is not actually when the analyzer finds the state specified in the "Trigger on" field; rather the trigger point is the *first entry* of the sequence level following the level containing the "Trigger on" field.**

To illustrate this point, select:

Analysis, Trace, Modify

Modify the trace specification as shown in figure 3-15.

```
Internal State Trace Specification
1 While storing any state
  Find no state 1 times
  Else on any state go to level 3
2 While storing any state
  Trigger on no state 1 times
  Else on no state go to level 1
3 While storing any state
  Then find no state 1 times
  go to level 1

Branches per level Count time Prestore off Trigger position
center of 512

STATUS: M68000--Running user program Emulation trace complete

Use the TAB and Shift-TAB keys to select a trigger position or enter a number.
```

Figure 3-15. Using Multiple Trigger Levels

You might think that because the "Trigger on" field contains "no state" the analyzer will never trigger. But, according to the statement above, the analyzer will trigger because the branch from sequence level one is to the level following the one containing "Trigger on". To verify that this is true, select:

Analysis, Begin

The "Trace complete" message is shown on the status line, indicating that the analyzer has indeed triggered.



Examples 3-45

Notes



Using the External Analyzer

Introduction

Most HP 64700 Series emulators may be ordered with an external analyzer. The external analyzer provides 16 external data channels. These data channels allow you to capture activity on signals external to the emulator, typically other target system signals. The external analyzer may be configured as an extension to the internal emulation analyzer, as an independent external state analyzer, or as an independent external timing analyzer.

The PC Interface is different in the following ways when an external analyzer is present:

1. The "Analysis System" command is available so that you can select the external analyzer mode.
2. The "Internal" and "External" command options are present so that you can specify, when the external analyzer is configured as an independent analyzer, which analyzer the command is for.
3. The "Analysis Format" screen provides fields for selecting the threshold voltages for the external trace signals, shows the activity on the external trace signals, and allows you to define trace labels for the external analyzer trace signals.
4. The predefined "xbits" external analyzer trace label appears in the "Analysis Format" screen and in the trace specification screen.

Before You Can Use the External Analyzer

There are several things to do before you can use the external analyzer; these things are listed below and explained in the following paragraphs.

- Assemble the analyzer probe.
- Connect the probe to the emulator.
- Connect the probe wires to the target system.
- Specify the threshold voltages for the external probe signals.
- Label the external trace signals.
- Select the external analyzer mode.

Assembling the Analyzer Probe

The analyzer probe is a two-piece assembly, consisting of ribbon cable and 18 probe wires (16 data channels and the J and K clock inputs) attached to a connector. Either end of the ribbon cable may be connected to the 18 wire connector, and the connectors are keyed so they may only be attached one way. Align the key of the ribbon cable connector with the slot in the 18 wire connector, and firmly press the connectors together. (See figure 4-1.)

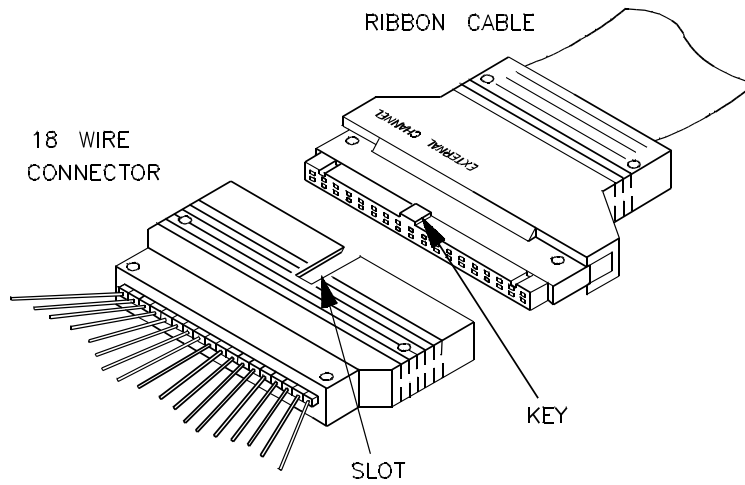

Figure 4-1. Assembling the Analyzer Probe

Each of the 18 probe wires has a signal and a ground connection. Each probe wire is labeled for easy identification. Thirty-six grabbers are provided for the signal and ground connections of each of the 18 probe wires. The signal and ground connections are attached to the pin in the grabber handle. (See figure 4-2.)

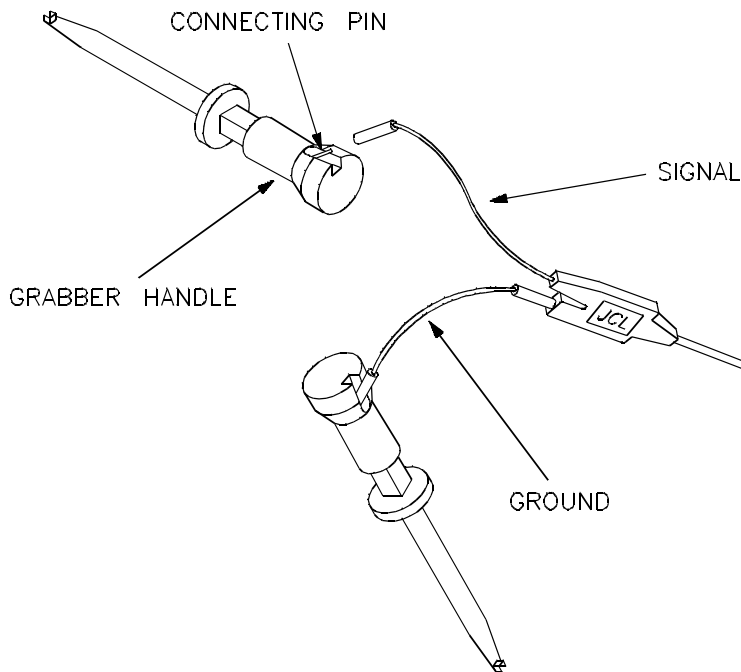

Figure 4-2. Attaching Grabbers to Probe Wires

Connecting the Probe to the Emulator

The external analyzer probe is attached to a connector under the snap-on cover in the front upper right corner of the emulator. Remove the snap-on cover by pressing the side tabs toward the center of the cover; then, pull the cover out. (See figure 4-3.)

Note



Check for bent connector pins before connecting the analyzer probe to the emulator.

4-4 Using the External Analyzer

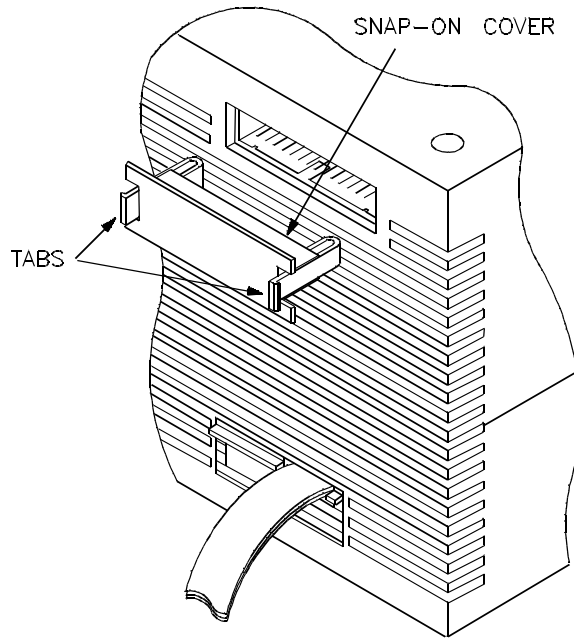

Figure 4-3. Removing Cover to Emulator Connector

Each end of the ribbon cable connector is keyed so that it can be connected to the emulator in only one way. Align the key of the ribbon cable connector with the slot in the emulator connector, and gently press the ribbon cable connector into the emulator connector. (See figure 4-4.)

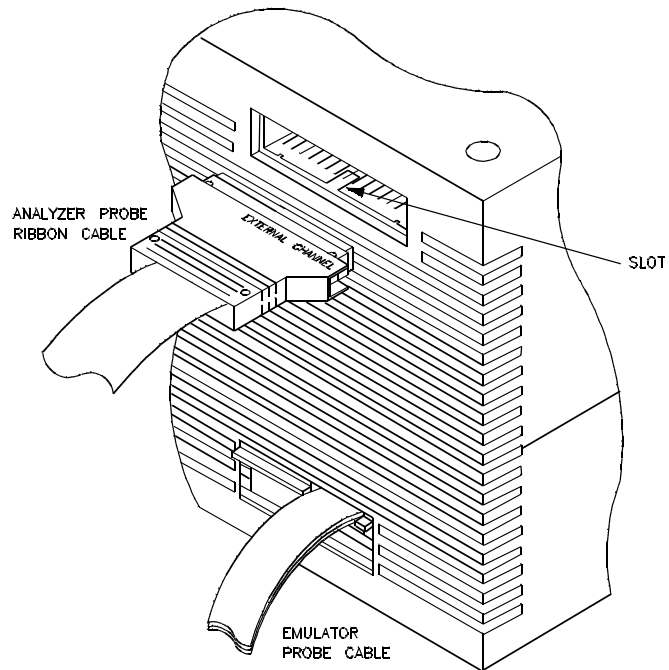

Figure 4-4. Connecting the Probe to the Emulator

4-6 Using the External Analyzer

Caution

Turn OFF target system power before connecting analyzer probe wires to the target system. The probe grabbers are difficult to handle with precision, and it is extremely easy to short the pins of a chip (or other connectors which are close together) with the probe wire while trying to connect it.

Connecting Probe Wires to the Target System

You can connect the grabbers to pins, connectors, wires, etc., in the target system. Pull the hilt of the grabber towards the back of the grabber handle to uncover the wire hook. When the wire hook is around the desired pin or connector, release the hilt to allow the tension of the grabber spring to hold the connection. (See figure 4-5.)

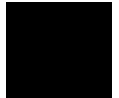

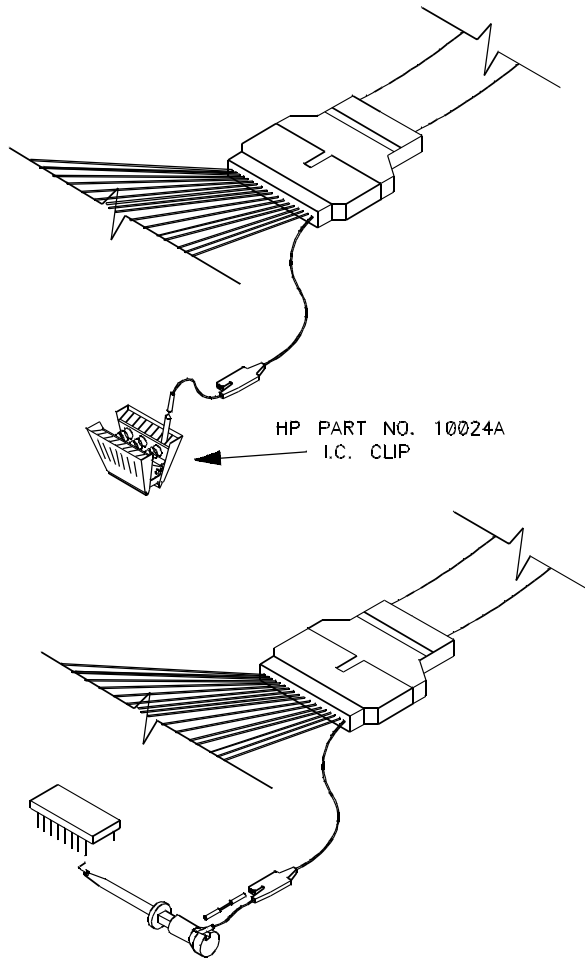

Figure 4-5. Connecting the Probe to the Target System

4-8 Using the External Analyzer

Specifying Threshold Voltages & Defining Labels

To specify threshold voltages for the external probe signals, select:

Analysis, **F**ormat, **I**nternal

An example format specification display is shown in figure 4-6. This screen allows you to specify threshold voltages, informs you of activity on the external analyzer trace signals, and allows you to define external analyzer labels.

When you are done specifying the threshold voltages and defining labels, press **End** and **Enter** to save your specifications. To exit without making changes to this label configuration, press **Esc**.

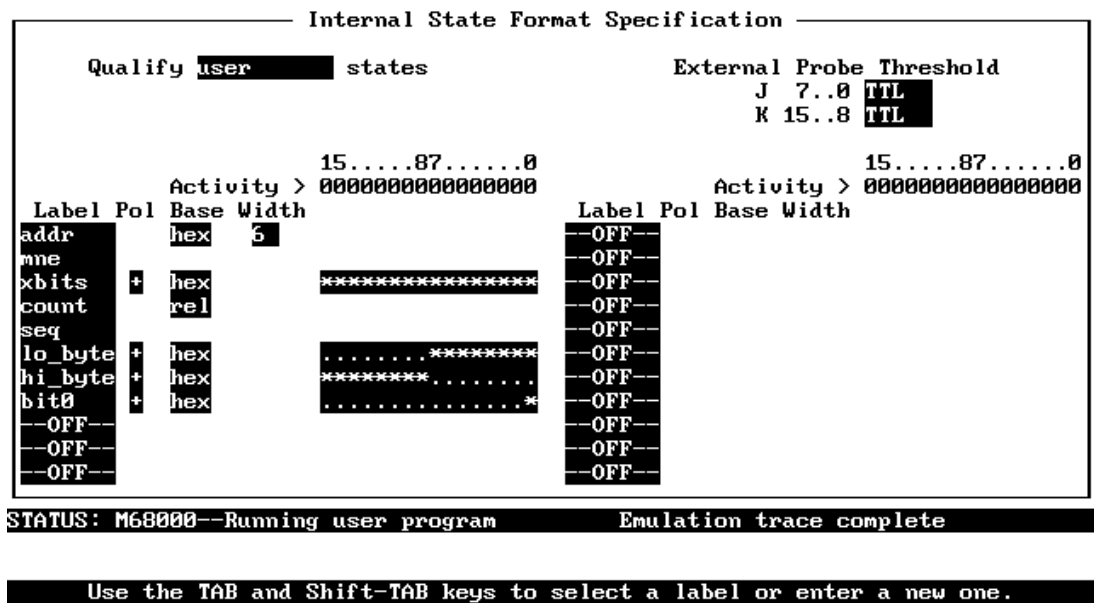

Figure 4-6. Analysis Format Display

Specifying Threshold Voltages

The external probe signals are divided into two groups, the lower byte (channels 0 through 7), and the upper byte (channels 8 through 15). Threshold voltage levels can be specified for each group. When the cursor is in one of the threshold voltage fields, you can use the **Tab** key to select one of the following values, or you can type in the voltage:

TTL 1.4 volts.

CMOS 2.5 volts.

ECL -1.3 volts.

<number> You can type in a threshold voltage. Voltages may be from -6.4 volts to 6.35 volts with a 50 mV resolution.

Note



The threshold settings will not take effect until the next time you begin a trace.

External Trace Signal Activity

This line of the display shows the activity on the external trace signals. A trace signal is specified as low (0) when it is below the threshold voltage, high (1) when it is above the threshold voltage, or moving (double headed arrows).

Defining External Analyzer Labels

The format specification screen allows you to define external analyzer labels. When you initially enter the PC Interface, one label, "xbits", is predefined. The "xbits" label includes all 16 external channels as specified by asterisks in the label value field.

You can define labels by moving the cursor to one of the label fields, typing in a label name (embedded spaces are not allowed), and pressing **Enter**. Once you have entered a label name, a label value field appears. The label value field allows you to specify the external

channels that make up the label. The label value field allows you to mask off unused or unimportant external channels.

New "label value" fields contain all periods. This means that the label does not currently represent any timing signals (all external channels are masked). To specify channels that the label is to represent, simply move the cursor to the appropriate column, and either use the **Tab** key to select an asterisk (include signal in the label) or type the asterisk key.

In figure 4-6, the external analyzer labels "lo_byte", "hi_byte", and "bit0" are user-defined.

Selecting the External Analyzer Mode

The external analyzer may be configured as an extension to the emulation analyzer, as an independent state analyzer, or as an independent timing analyzer. To specify the external analyzer mode, select:

Analysis, System

Press the **Tab** key to scroll through the various options:

aligned with internal In this mode, the external analyzer becomes an extension of the internal emulation analyzer. In other words, they operate as one analyzer. The external trace signals may be used to capture target system signals synchronized with the emulation clock.

external state analyzer In this mode, the external analyzer operates as an independent state analyzer. The independent state analyzer is identical to the emulation analyzer, except that only 16 bits of analysis are available. Your HP 64700 Series emulator now contains two state analyzers; two sets of analyzer resources (trace memory, patterns, qualifiers, etc.) are available, one for the emulation analyzer and one for the independent state analyzer.

When one of the independent analyzer modes is selected, you can use one analyzer to arm the other. You can specify the arm condition as a qualifier, perhaps as the trigger condition (cross-triggering).

(Refer to the "Making Coordinated Measurements" chapter for more information on cross-triggering.)

external timing analyzer In this mode, the external analyzer operates as an independent timing analyzer. Refer to the "Using the External Timing Analyzer" for more information.



Using the External Analyzer when Aligned with Internal

When the "aligned with internal" mode of the external analyzer is selected, it operates (from the PC Interface) as an extension to the emulation analyzer. In other words, they operate as one analyzer. External data is captured on the emulation clock as are the address, data, and status signals.

When an external analyzer is present, you may enter external data qualifiers in the trace specification, as shown in figure 4-7, by assigning values to "xbits", or to user-defined external analyzer labels such as "lo_byte", "hi_byte", or "bit0". Also, the trace display may contain additional columns showing the data captured on the external channels, as shown in figure 4-7. (You can use the **CTRL** and right-arrow or left-arrow keys to view columns that are beyond the width of the window.)

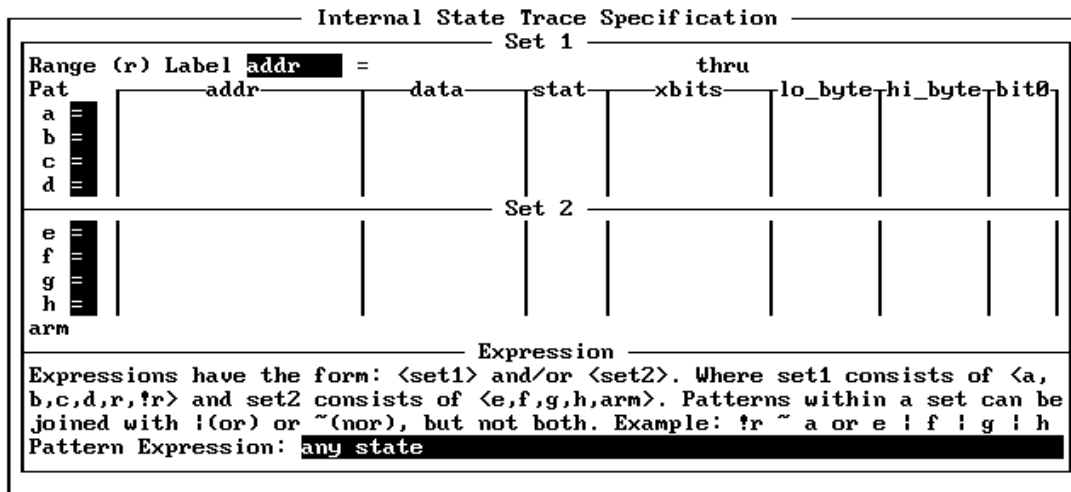

STATUS: M68000--Running user program Emulation trace complete

TAB selects a simple pattern or enter an expression or move up to edit patterns.

Analysis

,H	xbits,H	count,R	seq	lo_byte,H	hi_byte,H	bit0,Y
ata rd word	0000	---	+	00	00	0
ata rd word	0000	0.480 uS	.	00	00	0
6	0000	0.520 uS	.	00	00	0
d prefetch	0000	0.480 uS	.	00	00	0
,D2	0000	0.760 uS	.	00	00	0
rog	0000	0.480 uS	.	00	00	0
040a	0000	0.520 uS	.	00	00	0
rog	0000	0.480 uS	.	00	00	0
	0000	0.760 uS	.	00	00	0
	0000	0.520 uS	.	00	00	0
a	0000	0.480 uS	.	00	00	0
rog	0000	0.520 uS	.	00	00	0
ata wr word	0000	0.720 uS	.	00	00	0
ata wr word	0000	0.520 uS	.	00	00	0
0,D0	0000	0.480 uS	.	00	00	0
rog	0000	0.520 uS	.	00	00	0

STATUS: M68000--Running user program Emulation trace complete

Window System Register Processor Breakpoints Memory Config Analysis
 Begin Halt CMB System Format Trace Display

Figure 4-7. External Data in the Trace

Using the External State Analyzer

When you select the "external state analyzer" mode, the external analyzer operates as an independent state analyzer. You use the independent state analyzer in the same way as you use the internal analyzer, except that you must select the external analyzer clock source and specify the maximum qualified clock speed. Both of these specifications are made in the external analysis format screen (see figure 4-8) which you access by selecting:

Analysis, Format, External

```

External State Format Specification
-----
Qualify States      Clock Speed      Clock on      External Probe Threshold
  all                Slow                J ↓          J 7..0 TTL
                   K off                K 15..8 TTL
                   15....87.....0
Activity > 0000000000000000
Label Pol Base      Label Pol Base
xbits + hex          OFF
count rel           OFF
seq                OFF
-OFF-              OFF
-OFF-              OFF
-OFF-              OFF
-OFF-              OFF
-OFF-              OFF
-OFF-              OFF
-OFF-              OFF
-OFF-              OFF
-OFF-              OFF
-OFF-              OFF
<↑↓> :Interfield movement  Ctrl ←→ :Field editing  TAB :Scroll choices
STATUS: M68000--Running user program      Internal halted, External halted
  
```

Use the TAB and Shift-TAB keys to select the states qualified for the analyzer.

Figure 4-8. Analysis Format Display

Selecting the Clock Source

The independent state analyzer may be clocked with target system clock signals connected to the JCL and KCL external clock inputs.

Notice that there are two "Clock on" fields (see figure 4-8), one for the J signal and one for the K signal. Position the cursor in one of these

fields and press the **Tab** key repeatedly to view the following selections.

- <rising edge> Selects the rising edge of this signal as the clock.
- <falling edge> Selects the falling edge of this signal as the clock.
- <both edges> Specifies that the external analyzer be clocked on both the rising and falling edges of this signal.
- high Specifies this signal as a qualifying signal that only allows the other signal to clock the analyzer when the qualifying signal is higher than the threshold voltage (see figure 4-9).
- low Specifies this signal as a qualifying signal that only allows the other signal to clock the analyzer when

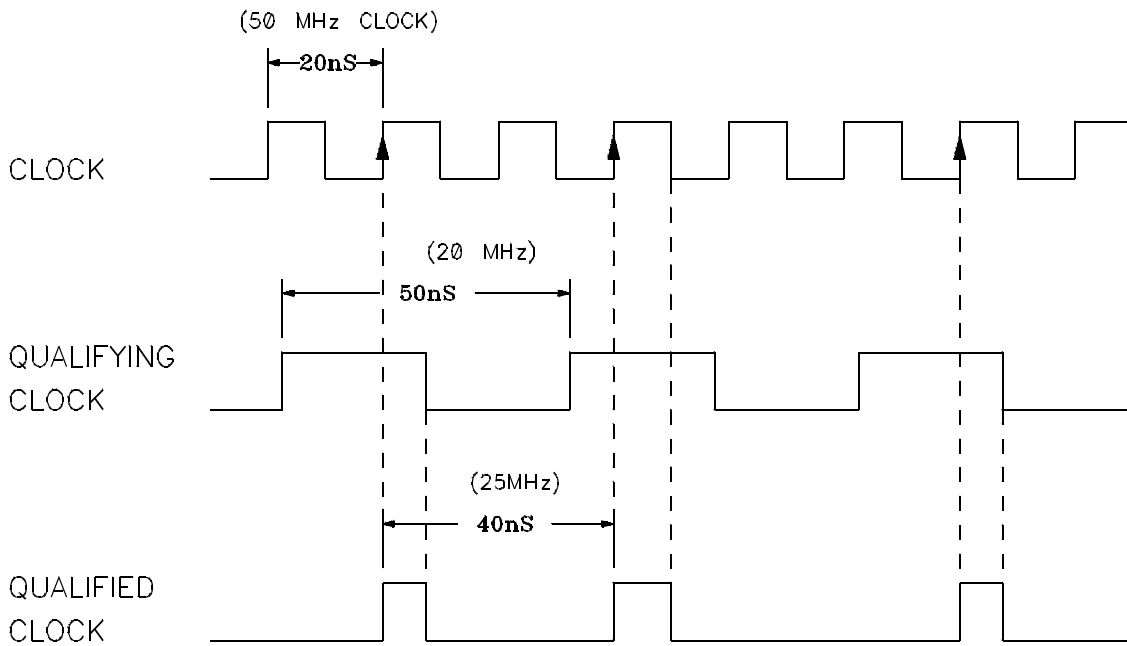
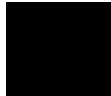

Figure 4-9. Qualified Clocks

the qualifying signal is lower than the threshold voltage.

off Specifies that this signal is not used.

When edges are specified for both the J and K signals, the external analyzer clocks on any of the specified edges.

Setup time for qualifying signals is approximately 20 nanoseconds. Qualifying signal hold time is approximately 5 nanoseconds.



Specifying the Maximum Qualified Clock Speed

The maximum qualified clock rate is the repetition rate of all specified clock signals (see figure 4-9). When selecting the maximum qualified clock speed of the analyzer, there are tradeoffs involving the trace count qualifier to be considered. You select the maximum qualified clock speed in the "Clock Source" field of the "Analysis Format External" screen (see figure 4-8). There are three maximum speeds that can be specified:

slow Slow specifies a maximum qualified clock rate of 16 MHz. When "slow" is selected, there are no restrictions on the trace count qualifier.

fast Fast specifies a maximum qualified clock rate of 20 MHz. When "fast" is selected, the trace count qualifier may be used to count states but not time.

very fast Very fast specifies a maximum qualified clock rate of 25 MHz. When "very fast" is selected, the trace count qualifier may not be used at all (in other words, the count qualifier field in the trace specification screen must be "off").

External Analyzer Specifications

- Threshold Accuracy = ± 50 mV.
- Threshold Voltage Range = 6 V to -6 V.
- Dynamic Range = ± 10 V about threshold setting.
- Minimum Input Swing = 600 mV pp.
- Minimum Input Overdrive = 250 mV or 30% of threshold setting, whichever is greater.
- Absolute Maximum Input Voltage = ± 40 V.
- Probe Input Resistance = 100K ohms $\pm 2\%$.
- Probe Input Capacitance = approximately 8 pF.
- Maximum +5 V Probe Current = 0.650 A.
- +5 V Probe Voltage Accuracy = +5.0 $\pm 5\%$.

External State Analyzer Specifications

- Data Setup Time = 10 ns min.
- Data Hold Time = 0 ns min.
- Qualifier Setup Time = 20 ns min.
- Qualifier Hold Time = 5 ns min.
- Minimum Clock Width = 10 ns

- Minimum Clock Period:
 - No Tagging Mode = 40 ns (25 Mhz clock).
 - Event Tagging Mode = 50 ns (20 MHz clock).
 - Time Tagging Mode = 60 ns (16 MHz clock).
- Minimum Time from Slave Clock to Master Clock = 10 ns.
- Minimum Time from Master Clock to Slave Clock = 50 ns.

Using the External Timing Analyzer

Introduction

The external analyzer can be aligned with the internal emulation analyzer, configured as an external state analyzer, or configured as an external timing analyzer. This chapter shows you how to use the external timing analyzer. The main sections in this chapter:

- Show you how to configure the external analyzer as a timing analyzer.
- Show you how to specify threshold voltages and define labels for the external probe signals.
- Describe the timing specifications.
- Describe the timing waveform display.
- Show you examples of using the external timing analyzer.

Note



Two versions of the PC Interface are shipped with your emulator; one contains interface software for the timing analyzer and the other does not. The version that contains the timing interface software is larger and requires most of the PC's 640K bytes of RAM. The version that does not contain the timing interface software requires approximately 480K bytes of RAM.

Prerequisites

Before you can use the external timing analyzer, you must have already completed the following tasks:

- You must be using the version of the PC Interface that gives you access to the external timing analyzer.
- The external analyzer probe must be assembled and connected to signals of interest as shown in the "Using the External Analyzer" chapter.



Configuring for Timing Analysis

To configure your emulator's external analyzer as a timing analyzer, select:

Analysis, **S**ystem

Now, use the **Tab** key to select "external timing analyzer" and press **Enter**.

When the external analyzer is configured as a timing analyzer, the "Analysis Trace **M**odify **E**xternal" command gives you a special timing analyzer trace specification screen (see figure 5-1) and the "Analysis **D**isplay **E**xternal" command gives you a timing waveform display.

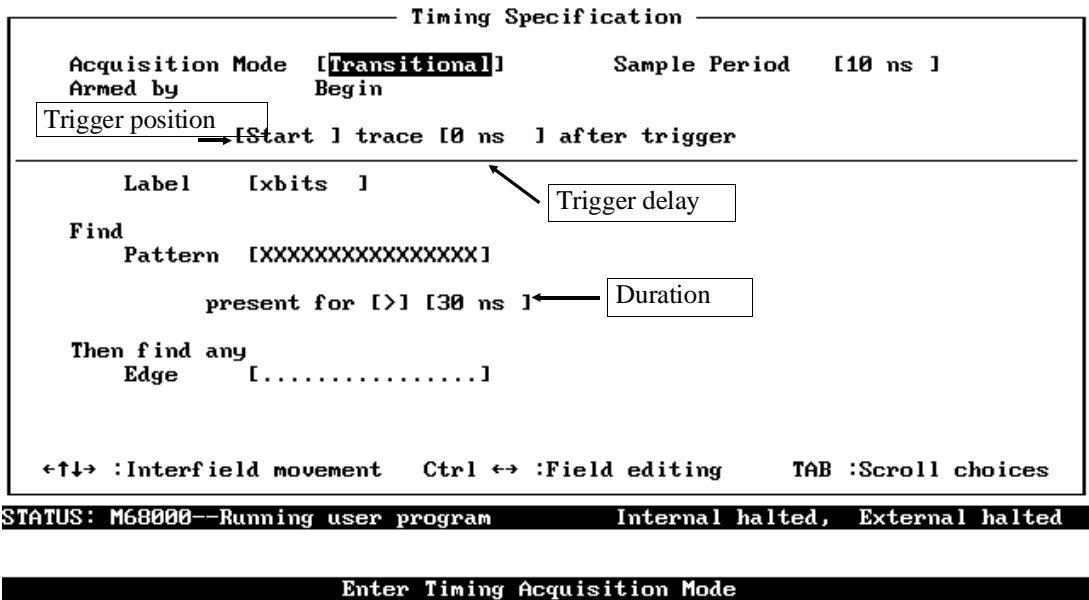

Figure 5-1. Timing Interface Main Display

Specifying Threshold Voltages & Defining Labels

To specify threshold voltages for the external probe signals, select:

Analysis, **F**ormat, **E**xternal

An example format specification display is shown in figure 5-2. This screen allows you to specify threshold voltages, informs you of activity on the external analyzer trace signals, and allows you to define timing labels.

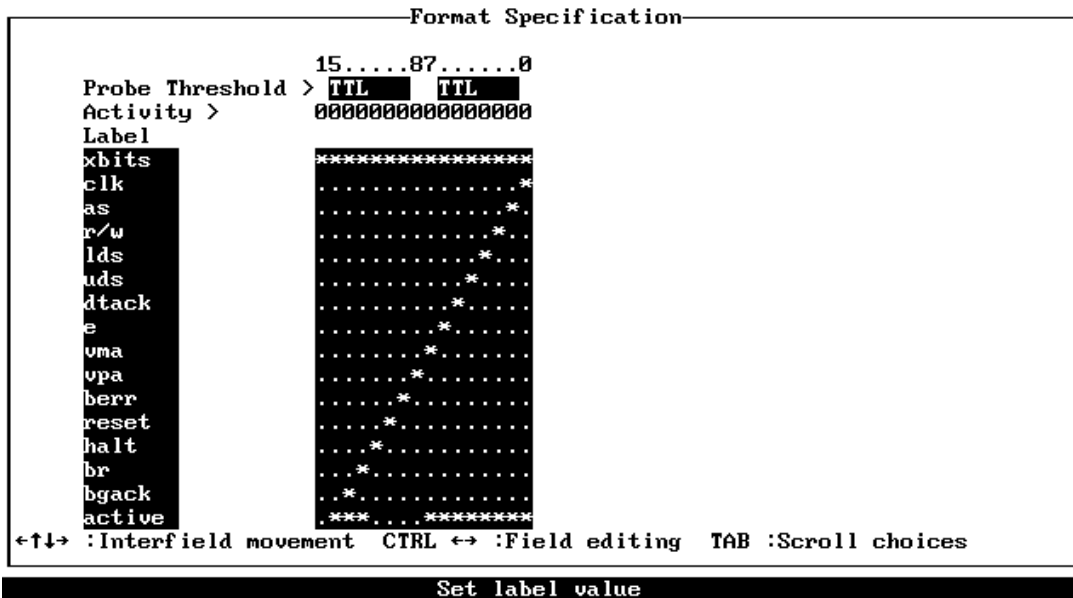

Figure 5-2. Timing Label Specification

When you are done specifying the threshold voltages and defining labels, press **End** and **Enter** to save your specifications. To exit without making changes to this label configuration, press **Esc**.

Threshold Voltages

The external probe signals are divided into two groups, the lower byte (channels 0 through 7), and the upper byte (channels 8 through 15). Threshold voltage levels can be specified for each group. When the cursor is in one of the threshold voltage fields, you can use the **Tab** key to select one of the following values, or you can type in the voltage:

- TTL 1.4 volts.
- CMOS 2.5 volts.
- ECL -1.3 volts.

<number> You can type in a threshold voltage. Voltages may be from -6.4 volts to 6.35 volts with a 50 mV resolution.

Activity This line of the display shows the activity on the external trace signals. A trace signal is specified as low (0) when it is below the threshold voltage, high (1) when it is above the threshold voltage, or moving (double headed arrows).

Labels The format specification screen allows you to define timing labels. When you initially enter the PC Interface, one label, "xbits", is predefined. The "xbits" label includes all 16 external channels as specified by asterisks in the label value field.

You can define labels by moving the cursor to one of the label fields, typing in a label name (embedded spaces are not allowed), and pressing **Enter**. Once you have entered a label name, a label value field appears. The label value field allows you to specify the external channels that make up the label. The label value field allows you to mask off unused or unimportant external channels.

New "label value" fields contains all periods. This means that the label does not currently represent any timing signals (all external channels are masked). To specify channels that the label is to represent, simply move the cursor to the appropriate column, and either use the **Tab** key to select an asterisk (include signal in the label) or type the asterisk key.

Labels can be used for signal identification in the waveform display. When a label consists of more than one signal, the signals within that label are numbered from the least significant active channel. For example, in figure 5-2, external channel 13 may be represented in the waveform display with the following names: xbits 13, bgack 00, or active 9.

Timing Specification

This section describes the options available when modifying the timing specification. To modify the timing specification, select:

Analysis, Trace, Modify, External

Brackets, [], in the timing specification display indicate fields in which the **Tab** key may be used to select choices.

When you are done modifying the timing specification, press **End** and **Enter** to save your specifications. To exit without making changes to the timing specification, press **Esc**.

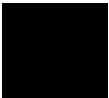

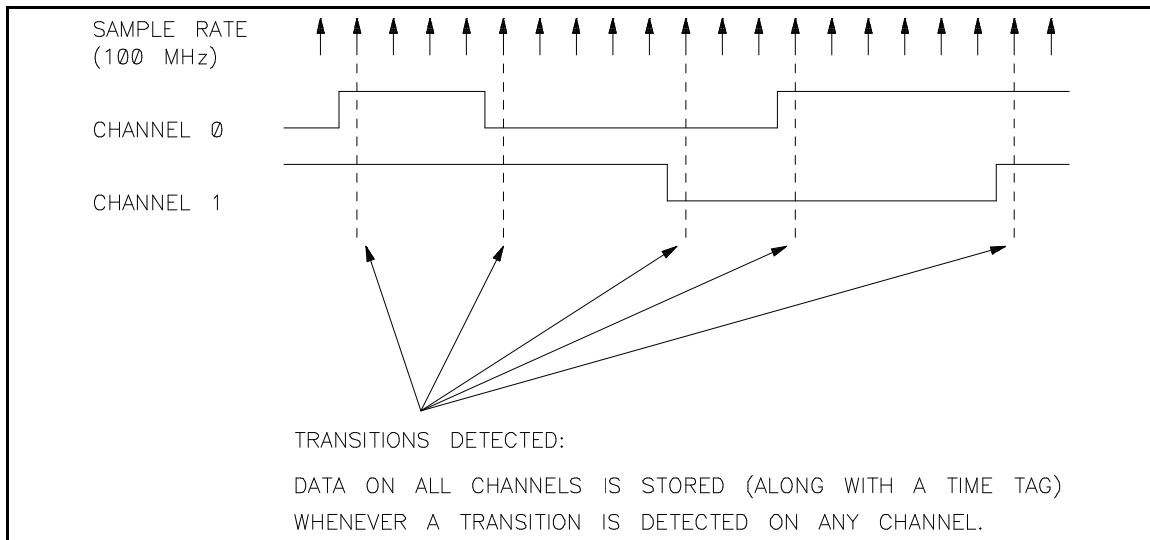

Figure 5-3. Transitional Acquisition Mode

Acquisition Modes

You can use the external timing analyzer in one of three modes: transitional, standard (data acquisition), or glitch (data and glitch acquisition).

Transitional

In the transitional mode, data is sampled at 100 MHz, but stored only when an input transition (on any channel) is detected. A time tag is also stored so that the data can be accurately placed in the display. This mode allows the effective time window stored to be increased while maintaining resolution.

The number of data transitions stored depends on the incoming data transmission rate. The minimum number of data transitions that will be stored is 128. Because time tags are also stored, the maximum number of transitions that can be stored is 512. See figure 5-3.

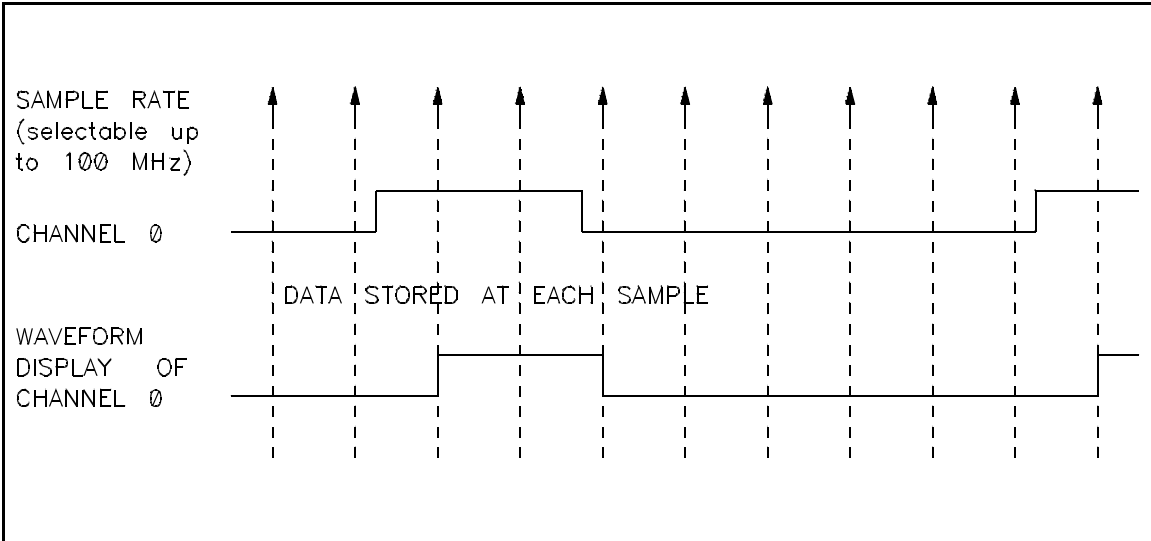

Figure 5-4. Standard Acquisition Mode

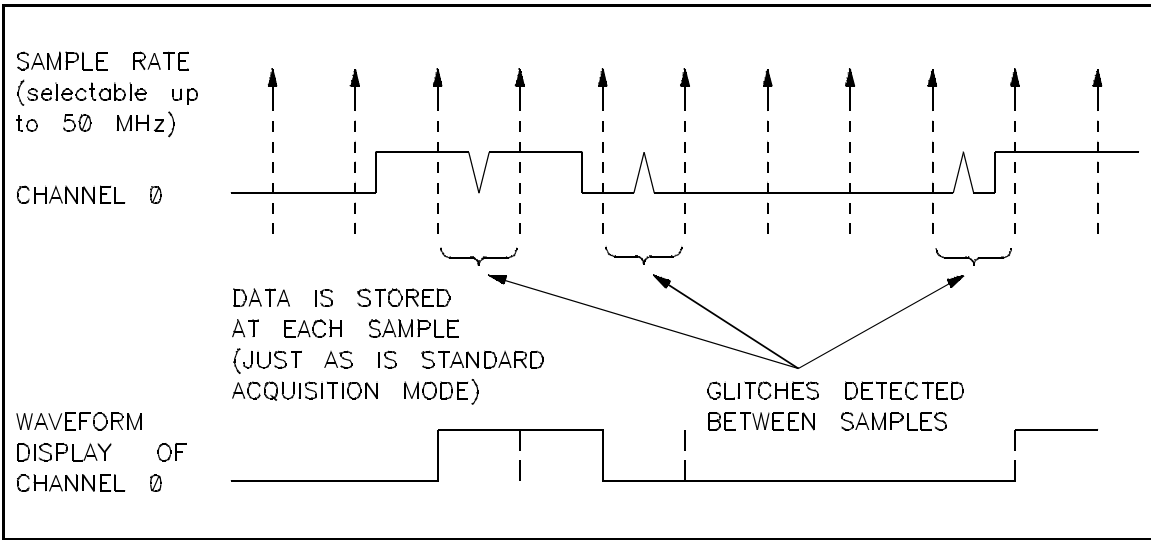

Figure 5-5. Glitch Acquisition Mode

5-8 Using the External Timing Analyzer

Standard

In the standard mode, the timing analyzer samples data on the external analyzer probe at the selected sample rate. Up to 1024 samples can be stored, and the maximum sample rate is 100 MHz (10 ns intervals). See figure 5-4.

Glitch

This is the same as the standard acquisition mode except that glitch information is also stored at each sample. A glitch is detected when there are two or more transitions on a signal between samples. The storing of glitch information reduces the number of samples that can be stored to 512, and the maximum sample rate is 50 MHz (20 ns intervals). See figure 5-5.

Sample Period

The sample period in the transitional acquisition mode is always 10 ns.

Valid periods in the standard acquisition mode are between 10 ns and 50 ms in a 1/2/5 sequence.

Valid periods in the glitch acquisition mode are between 20 ns and 50 ms in a 1/2/5 sequence.

The accuracy of the sample rate is that of the crystal oscillator, approximately +/- 0.01%.

Armed By

The "Armed by" field reflects the arm condition of the external analyzer.

Begin

When "Armed by Begin" is shown, the external analyzer is always armed. This means that the analyzer can perform measurements at any time.

TRIG1 or TRIG2

When "Armed by TRIG1" or "Armed by TRIG2" is shown, the external analyzer cannot perform a measurement until the arm is received from an external trigger signal.

External trigger signals can drive the external analyzer over the TRIG1 or TRIG2 signals, as specified in the Trigger Configuration (see the "Allowing CMB and BNC Triggers to Arm the Analyzer" section in the "Coordinated Measurements" chapter).

Trigger Position

The trigger position option allows you to place the trigger at the start, center, or end of the trace. For example, if you wanted to look at events before the trigger, you would place the trigger at the end of the trace.

Trigger Holdoff (Prestore)

Trigger holdoff is the number of samples that are stored before the trigger will be recognized. Trigger holdoff is as follows for the three timing modes:

Transitional Mode	None.
Standard Mode	Start trace = 60 samples. Center trace = 512 samples. End trace = 960 samples.
Glitch Mode	Start trace = 30 samples. Center trace = 256 samples. End trace = 480 samples.

Trigger Delay

Timing trigger delay is the amount of time to delay the trigger after a valid trigger condition. Trigger delay can be anywhere between 0 and 10 ms in 10 ns increments.

Label Qualifier

The "Label" field in the timing specification display allows you to select one of the defined labels. You can use the **Tab** key to scroll through the defined labels. Once a label is selected, you can then specify patterns, edges, or glitches on the data channels associated with that label. The trigger condition is the combined specifications of all labels (that is, the pattern, edge, or glitch specifications for each label are ORed together to form the complete specification for the 16 external data channels).

All defined labels can appear in the waveform display regardless of the label qualifier selected.

Specifying the Trigger Condition

The timing specification options described above tell the timing analyzer how to capture data and how to display it, but they do not tell the analyzer when to capture data; this is done by specifying the trigger condition. The "Find" and "Then Find" options allow you to specify the trigger condition.

There are three types of trigger conditions:

1. **Pattern Trigger.** This type of trigger condition occurs when no edges (or glitches if the glitch acquisition mode is enabled) are specified in the "Then Find" options. In order for the trigger condition to become true, the pattern specified must be present for greater than or less than a specified amount of time (duration).
2. **Edge Trigger.** This type of trigger condition can only occur when edges are specified in the "Then Find" options and a greater than duration is specified. In order for this trigger condition to become true, the specified pattern trigger must be found and be present for greater than the specified period of time, and a specified edge must be found while the pattern is still present.
3. **Glitch Trigger.** This type of trigger condition can only occur in the glitch acquisition mode when glitches are specified in the "Then Find" options and a greater than duration is specified. In order for this trigger condition to become true, the specified pattern must be found and be present for greater than the specified period of time, and a specified glitch must be found while the pattern is still present.

These three types of trigger conditions are described below.

Find Pattern

Find pattern allows you to specify a data pattern consisting of 1's, 0's, or X's (don't cares) across the 16 channels. The most significant bit is channel 15 and least significant bit is channel 0.

Use the field editing keys to position the cursor to the different channels, and use the **Tab** key to select the appropriate value.

Duration

The "present for" option allows you to specify a pattern duration greater than or less than a specified amount of time before the pattern trigger condition is met.

If the pattern is valid but the duration is not met, there is a 20 ns reset time before looking for a pattern again.

Greater Than Duration

The trigger occurs after the pattern is present on the probe for the specified time duration. Selectable from 30 ns to 10 ms in 10 ns increments.

Less Than Duration

The trigger occurs when the specified pattern is present on the probe inputs for greater than 20 ns but less than the specified time duration. Selectable from 40ns to 10 ms in 10 ns increments.

An example pattern trigger, with a duration greater than 30 ns, is shown in figure 5-6.

```

Timing Specification
-----
Acquisition Mode [Standard ]      Sample Period [10 ns ]
Armed by         Begin
                [Start ] trace [0 ns ] after trigger

Label [xbits ]

Find
Pattern [XXXXXXXX0011101X]
        present for [>] [30 ns ]

Then find any
Edge [.....]

<↑↓> :Interfield movement  Ctrl ←> :Field editing  TAB :Scroll choices

```

STATUS: M68000--Running user program Internal halted, External halted

Enter Trigger Value for Current Channel

```

Time/division [ 50 ns]      Sample period 10 ns      -580.0 ns trigger to x
Magnify about [x]          0.0 ns o to x          -580.0 ns trigger to o
Cursor moves [ x ]

```

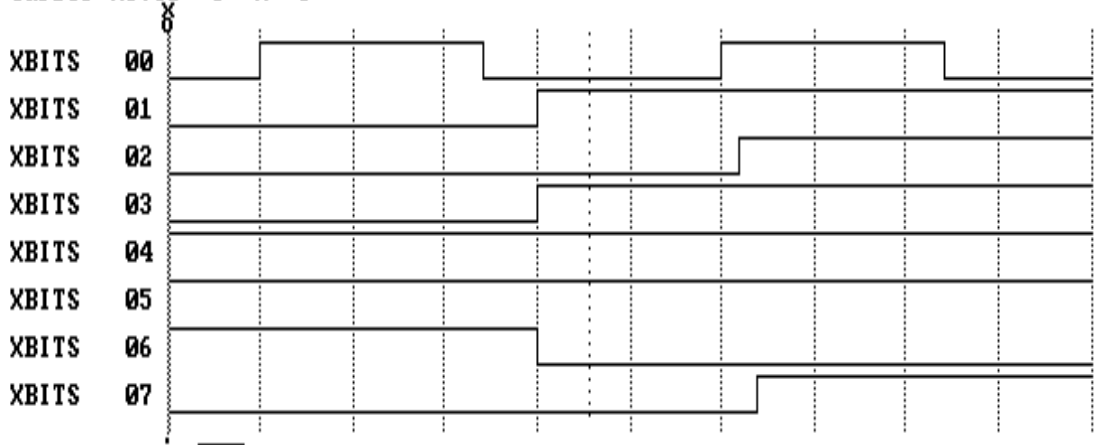

STATUS: M68000--Running user program Trace complete
B :Begin Trace H :Halt Trace
↑↓ :Next Field ←> :Move Cursor CTRL ↑> :Scroll Wave TAB :Scroll Choices

Figure 5-6. Pattern Trigger

Then Find Edge or Glitch

Edge or glitch triggers occur after the pattern has been present on the probe for the specified duration and, while the pattern is still present, an edge or glitch occurs on any of the selected channels. Edges on each channel can be specified as rising, falling, or either rising or falling.

Edge triggers may only be specified with "greater than" durations. See figure 5-7 for an edge trigger example.

Glitch triggers may only be specified while in the glitch acquisition mode and with "greater than" durations. See figure 5-8 for a glitch trigger example.



Reset

The timing specification reset command allows you to return the timing specification to its default values (see figure 5-1).

```

Timing Specification
Acquisition Mode [Standard ]      Sample Period [10 ns ]
Armed by         Begin
                [Start ] trace [0 ns ] after trigger
-----
Label   [xbits ]
Find
Pattern [XXXXXXXX0011101X]
        present for [>] [30 ns ]
Then find any
Edge    [.....↑..]
-----
←↑→ :Interfield movement  Ctrl ←→ :Field editing  TAB :Scroll choices

```

STATUS: M68000--Running user program Internal halted, External halted

Enter Edge Value for Current Channel

```

Time/division [ 50 ns]   Sample period 10 ns   -570.0 ns trigger to x
Magnify about [x]       0.0 ns o to x         -570.0 ns trigger to o
Cursor moves [ x ]

```

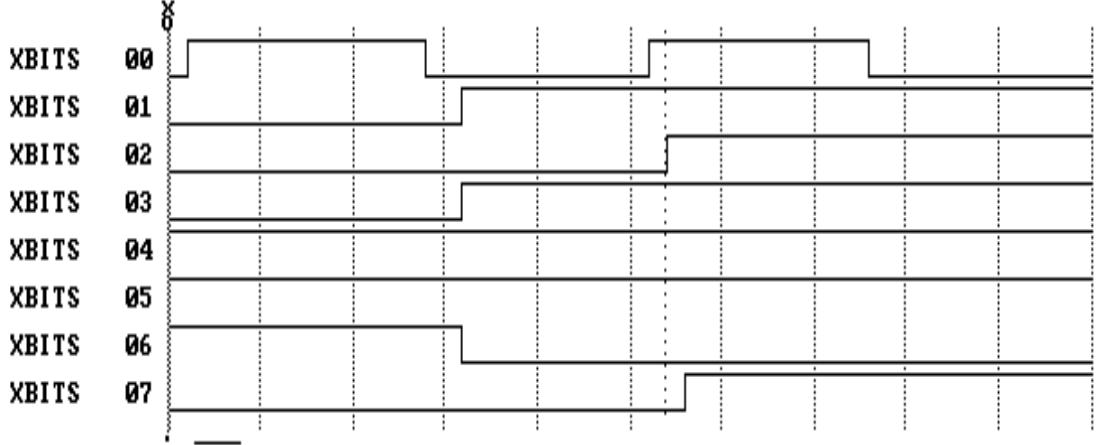

STATUS: M68000--Running user program Trace complete
 B :Begin Trace H :Halt Trace
 ↑ :Next Field ← :Move Cursor CTRL ↑ :Scroll Wave TAB :Scroll Choices

Figure 5-7. Edge Trigger

```

Timing Specification
Acquisition Mode [Glitch ]      Sample Period [20 ns ]
Armed by        Begin
                [Start ] trace [0 ns ] after trigger
-----
Label   [xbits ]
Find
Pattern [XXXXXXXX1011101X]
        present for [>] [30 ns ]
Then find any
Edge    [.....]
or
Glitch  [.....*..]
<↑↓> :Interfield movement  Ctrl ↔ :Field editing  TAB :Scroll choices

```

STATUS: M68000--Running user program Internal halted, External halted

Enter Glitch Value for Current Channel

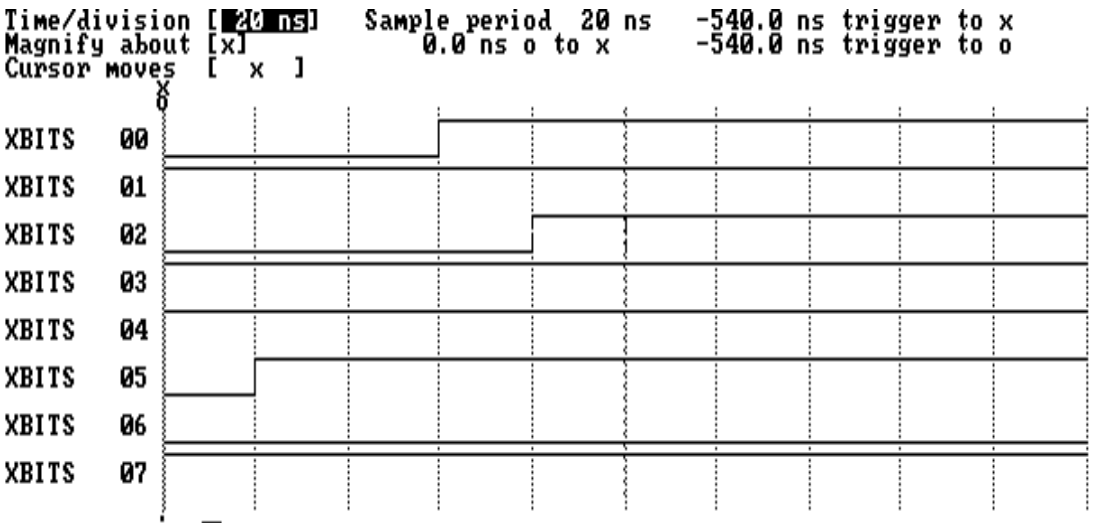

STATUS: M68000--Running user program Trace complete
B :Begin Trace H :Halt Trace
↑↓ :Next Field ↔ :Move Cursor CTRL ↑↓ :Scroll Wave TAB :Scroll Choices

Figure 5-8. Glitch Trigger

Timing Waveform Display

To view a timing waveform display, select:

Analysis, Display, External

You can exit the waveform display by pressing **ESC**, and you can re-enter the waveform display by selecting the "Analysis Display External" command. When you enter the waveform display, there are several fields which allow you to change how the trace information is displayed. This section describes the waveform display and the features that allow you to change the display. An example timing waveform display is shown in figure 5-9.

Setting the Time per Division

By moving the cursor to the time/division field and using the **Tab** key, you can change the time per division on the display. There are 10 divisions on the display, represented by vertical dotted lines.

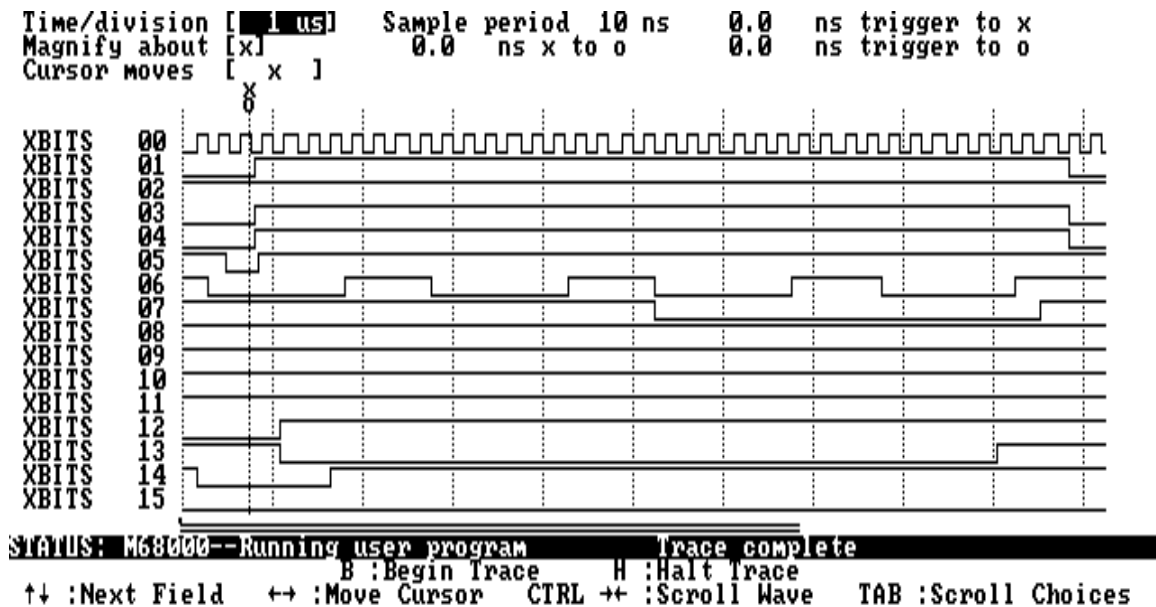

Figure 5-9. Timing Waveform Display

Scrolling through the Waveform Display

When the time per division is decreased, not all of the trace can be displayed on the screen. However, you can scroll the trace across the screen by pressing the **CTRL** left arrow and **CTRL** right arrow keys. The portion of the trace that is currently displayed is represented by a bar at the bottom of the screen.

Reference Points

Three reference points appear in the waveform display. The first is the trigger point. The two remaining reference points are movable, and you can place them at areas of interest in the trace.

Trigger

The trigger point is represented by the vertical dashed line. The trigger point is the actual trigger condition (pattern, edge, or glitch) plus the trigger delay.

User Defined (X, O)

The user defined reference points can be moved anywhere in the display. These points are also represented by vertical dashed lines, and they are labeled "x" and "o". The top of the waveform display shows time between these two points and the time between them and the trigger.

Cursor moves (X, O, X & O) The third field from the top allows you to select which reference points the cursor will move, "x", "o", or both "x & o".

Magnify About (X or O) Toggling the "display about" value from "x" to "o" causes the waveforms to be displayed about the different reference points.

Inserting/Deleting Channels

The **Insert** key allows you to increase the number of channels included in the waveform display. By inserting channels, you can display a maximum of 16 channels on the display.

Each channel can be used to display any of the defined labels.

The **Delete** key allows you to decrease the number of waveforms included on the display.

Examples

Starting the Timing Measurement

To start a timing measurement, select:

Analysis, **B**egin, **E**xternal

Also, while in the waveform display, you can enter the "B" key to start a timing measurement.

Halting the Trace

To halt a currently running timing measurement, select:

Analysis, **H**alt, **E**xternal

Also, while in the waveform display, you can enter the "H" key to halt a timing measurement.

External Timing Analyzer Specifications

Sample Rate Accuracy = 0.01%

Asynchronous Pattern. Trigger on pattern less than or greater than specified duration. Pattern is logical AND of specified low, high, or "don't care" for each channel. If pattern is true then false for less than the duration, there is a 20 ns reset time before looking for the pattern again.

Greater Than Duration. Range is 30 ns to 20 ms. Resolution is +/- 10 ns or 0.01%, whichever is greater. Accuracy is (10 ns + 0.01%) to (-30 ns - 0.01%).

Less Than Duration. Range is 40 ns to 10 ms. Resolution is +/- 10 ns or 0.01%, whichever is greater. Pattern must be valid for at least 20 ns. Accuracy is (30 ns + 0.01%) to (-10 ns - 0.01%).

Delay Accuracy = 0.01% +/- 10 ns

Minimum Detectable Glitch = 5 ns at threshold

Typical Skew < 4 ns

Making Coordinated Measurements

Introduction

Coordinated measurements are measurements synchronously made in multiple emulators or analyzers. Coordinated measurements can be made between HP 64700 Series emulators which communicate over the Coordinated Measurement Bus (CMB). Coordinated measurements can also be made between an emulator and some other instrument connected to the BNC connector.

This chapter will describe coordinated measurements which involve the emulation or external analyzers. These types of coordinated measurements are:

- Starting a trace on reception of the CMB EXECUTE signal.
- Using the analyzer trigger to break emulator execution into the monitor.
- Using the analyzer trigger to drive the CMB or BNC TRIGGER signal.
- Allowing CMB or BNC TRIGGER signals to arm the analyzer.
- Using the external analyzer to arm the emulation analyzer, and vice-versa.

Note



You must use the background emulation monitor to perform coordinated measurements. Refer to your *PC Interface: Emulator User's Guide* for more information on the emulation monitor.

Three signal lines on the CMB are active and serve the following functions when enabled:

- | | |
|----------------|--|
| TRIGGER | Active low. The analyzer trigger line on the CMB and on the BNC serve the same logical purpose. They provide a means for the analyzer to drive its trigger signal out of the system or for external trigger signals to arm the analyzer or break the emulator into its monitor. |
| READY | Active high. This line is for synchronized, multi-emulator start and stop. When CMB run control interaction is enabled, all emulators are required to break to background upon reception of a false READY signal and will not return to foreground until this line is known to be in a true state. |
| EXECUTE | Active low. This line serves as a global interrupt signal. Upon reception of an enabled EXECUTE signal, each emulator is to interrupt whatever it is doing and execute a previously defined process, typically, run the emulator or start a trace measurement. |

Tracing at EXECUTE

To specify that an analyzer measurement begin upon reception of the CMB EXECUTE signal, select the following PC Interface command:

`Analysis, CMB, Begin`

The trace measurement defined by the current trace specification will be started when the EXECUTE signal becomes active. When the trace measurement begins, you will see the message "ALERT: CMB execute; emulation trace started".

Using the Analyzer Trigger to Break into the Monitor

To cause emulator execution to break into the monitor when the analyzer trigger condition is found, you must modify the trigger configuration. To access the trigger configuration, select:

`Config, Trigger`

The trigger configuration display contains two diagrams, one for each of the internal TRIG1 and TRIG2 signals.

To use the internal TRIG1 signal to connect the analyzer trigger to the emulator break line, highlight the "Analyzer" field in the TRIG1 portion of the display, and use the **Tab** key to select the single-headed arrow pointing towards TRIG1; this shows that the analyzer is driving TRIG1.

Next, highlight the "Emulator" field and use the **Tab** key to select the arrow pointing towards the emulator; this specifies that emulator execution will break into the monitor when the TRIG1 signal is driven.

The resulting trigger configuration display is shown in figure 6-1.

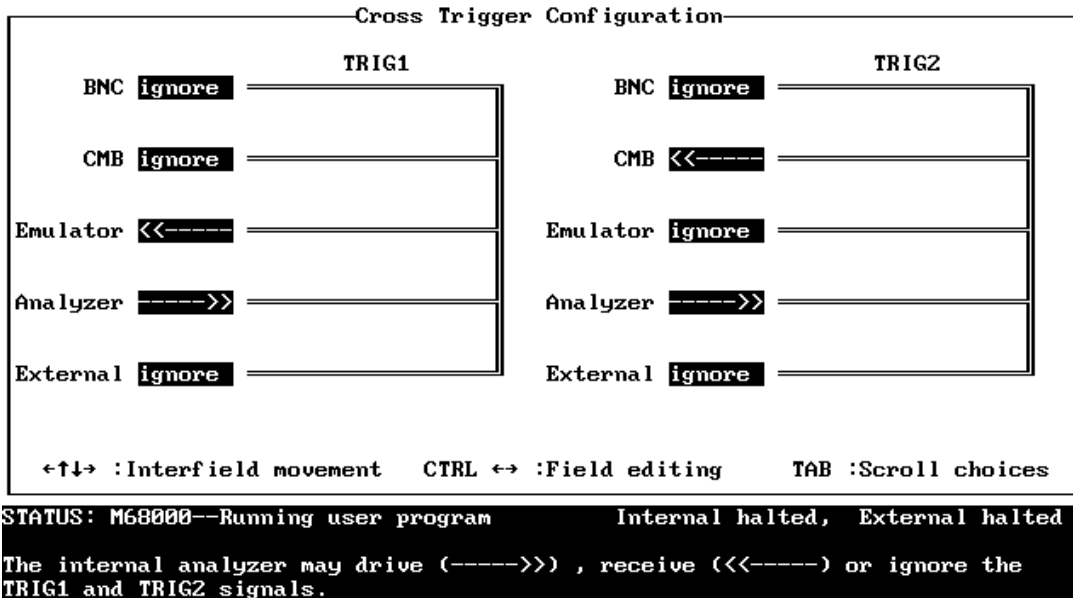

Figure 6-1. Cross Trigger Configuration

Both the emulation analyzer and the external analyzer may drive the same internal signal; in this case, the internal signal will be driven by the analyzer that finds its trigger condition (point) first.

Using the Analyzer Trigger to Drive External Signals

To specify that external TRIGGER signals (either CMB or BNC) become active when the analyzer trigger condition is found, access the trigger configuration by selecting:

Config, Trigger

To use the internal TRIG2 signal to connect the analyzer trigger to the CMB TRIGGER line, highlight the "Analyzer" field in the TRIG2 portion of the trigger configuration display, and use the **Tab** key to

select the single-headed arrow pointing towards TRIG2; this shows that the analyzer trigger is driving TRIG2.

Next, highlight the "CMB" field and use the **Tab** key to select the single-headed arrow pointing towards CMB; this shows that the CMB TRIGGER signal becomes active when the TRIG2 signal is driven.

This trigger configuration is also shown in figure 6-1.

Allowing CMB or BNC TRIGGERS to Arm the Analyzer

The two previous examples show how the analyzer can be used to drive signals. You can also specify that the analyzer be armed (turned on, or enabled) on the reception of CMB or BNC TRIGGER signals. (The analyzer is always armed unless one of these signals is specifically used to arm the analyzer.) Until the analyzer is armed, trace measurements cannot be performed.

Arming the Internal Emulation Analyzer

To arm the internal emulation analyzer on reception of an external CMB or BNC TRIGGER signal, select the following command from within the PC Interface:

```
Config, Trigger
```

For example, to specify that the state analyzer be armed by the CMB TRIGGER over TRIG2, highlight the "CMB" field and use the **Tab** key to select the single-headed arrow pointing towards TRIG2; this shows that the TRIG2 signal is driven when the CMB TRIGGER signal becomes active.

Next, highlight the "Analyzer" field in the TRIG2 portion of the display, and use the **Tab** key to select the arrow which points towards "Analyzer"; this shows that the analyzer trigger receives TRIG2.

This trigger configuration is shown in figure 6-2.

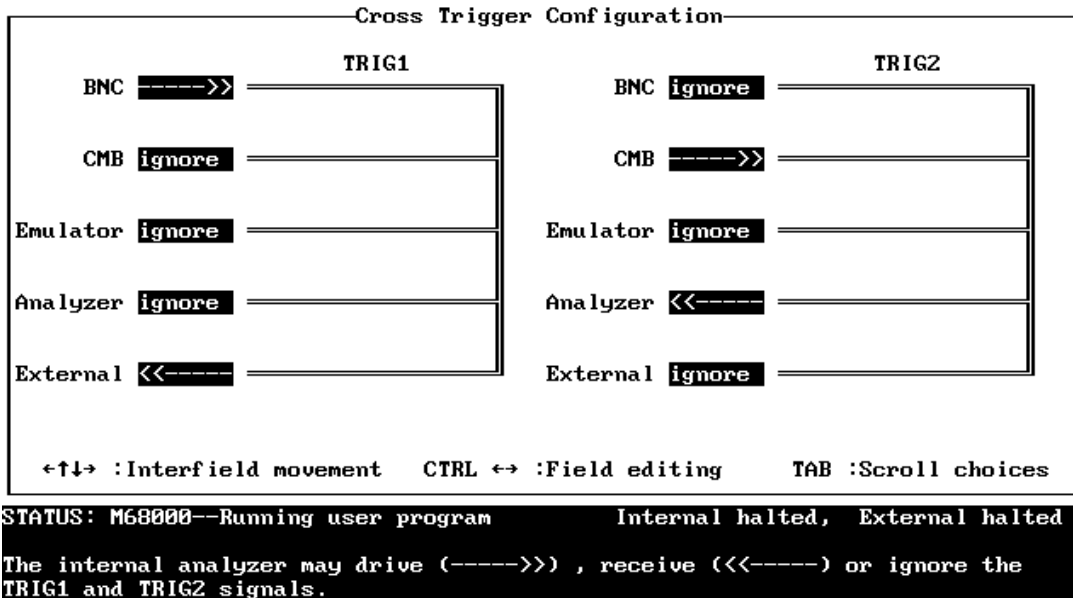

Figure 6-2. Receiving External Signals

In the internal emulation analyzer trace specification display, you can use the "arm" resource in any of the state qualifier fields. For example, if "arm" is shown in the "trigger on" field, the analyzer triggers when it is armed.

Arming the External Analyzer

To arm the external analyzer on reception of an external CMB or BNC TRIGGER signal, select the following command from within the Timing Interface:

Config, Trigger

For example, to specify that the timing analyzer be armed by the BNC TRIGGER over TRIG1, highlight the "BNC" field and use the **Tab** key to select the single-headed arrow pointing towards TRIG1; this shows that the TRIG1 signal is driven when the BNC TRIGGER signal becomes active.

Next, highlight the "External" field in the TRIG1 portion of the display, and use the **Tab** key to select the arrow which points towards "External"; this shows that the analyzer trigger receives TRIG1.

6-6 Making Coordinated Measurements

This trigger configuration is shown in figure 6-2.

In the external state analyzer trace specification display, you can use the "arm" resource in any of the state qualifier fields. For example, if "arm" is shown in the "trigger on" field, the analyzer triggers when it is armed.

When the external analyzer is configured as a timing analyzer and is to be armed by an external CMB or BNC TRIGGER signal, the timing trace specification display is updated to show "Armed by External". The timing measurement begins when the arm signal is received.

Using One Analyzer to Arm the Other

You can use the trigger condition of the external analyzer to arm the emulation analyzer, and vice-versa. To make a specification like this, you also select:

`Config, Trigger`

For example, in figure 6-3, the TRIG1 signal is used to arm the internal analyzer when the external analyzer's trigger condition is found.

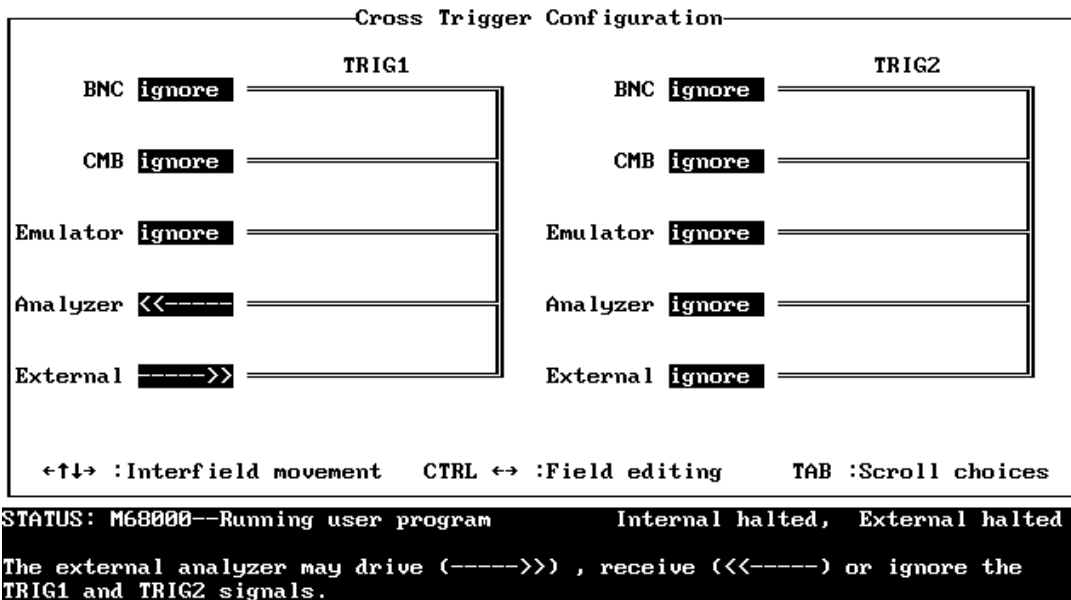

Figure 6-3. Using One Analyzer to Arm the Other

Other Trigger Combinations

You may have noticed that the CMB or BNC TRIGGER signals may be driven by the internal TRIG1 and TRIG2 signals, be received by external sources, or both. When a CMB or BNC signal is received from an external source, it may be used to break emulator execution into the monitor. When a CMB or BNC signal is both driven and received (double-headed arrow shown in the associated field), you can set up the emulation analyzer to drive the internal signal; if the internal signal drives the emulator break line, the emulator will break into the monitor on either the analyzer trigger or on the reception of an external TRIGGER signal.

6-8 Making Coordinated Measurements

When an emulator break occurs due to the analyzer trigger, the analyzer will stop driving the internal signal that caused the break. Therefore, if TRIG2 is used both to break and to drive the CMB TRIGGER (for example), TRIGGER will go true when the trigger is found and then will go false after the emulator breaks. However, if TRIG1 is used to cause the break and TRIG2 is used to drive the CMB TRIGGER, TRIGGER will stay true until the trace is halted or until the next trace starts.

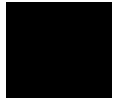

Notes

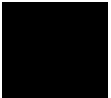

Index

- A**
 - absolute count display, **2-16**
 - absolute files, loading, **3-9**
 - acquisition modes, **5-7**
 - activity, external trace channels, **4-10, 5-5**
 - add operator, **2-9**
 - addr trace label, **2-10**
 - analysis begin, **2-13**
 - analysis display, **2-14**
 - analysis halt, **2-14**
 - analysis specification
 - trace at EXECUTE, **6-3**
 - analyzer
 - features of, **1-3**
 - internal, using the, **2-1**
 - analyzer probe
 - assembling, **4-2**
 - connecting to the emulator, **4-4**
 - connecting to the target system, **4-7**
 - AND operator (bitwise), **2-9**
 - armed by, timing specification, **5-9**
- B**
 - bases (number), **2-8**
 - binary numbers, **2-8**
 - bitwise AND operator, **2-9**
 - bitwise OR operator, **2-9**
 - bitwise XOR operator, **2-9**
 - BNC connector, **6-1**
 - branch state, **1-3, 2-5**
 - branches, **2-5**
 - per level, **3-27**
 - restart on, **3-24**
 - breaking into the monitor on trigger, **6-3**
- C**
 - channels, inserting/deleting from waveform display, **5-19**
 - clock source for external state analyzer, **4-14**
 - clock speed, maximum qualified, **4-16**

CMB (coordinated measurement bus), **6-1**
signals on, **6-2**
CMOS threshold voltage specification, **4-10, 5-4**
constants, **2-8**
coordinated measurements, **1-5**
definition, **6-1**
count information in the trace listing, **1-3**
count information in trace listing, **2-15**
count qualifiers, **2-6, 3-21**
counts
displaying relative or absolute, **2-16**
cross-arming emulation and external analyzers, **6-7**

D data trace label, **2-11**
decimal numbers, **2-8**
default trace specification, **2-2**
DeMorgan's law, **2-13**
display about x or o, timing waveform display, **5-18**
displaying the trace, **2-14**
divide operator, **2-9**
don't care digits, **2-8**
duration, **5-12**

E ECL threshold voltage specification, **4-10, 5-4**
edge trigger, **5-11, 5-14**
emulation analyzer
definition, **1-1**
emulator status lines, predefined values for, **2-11**
EXECUTE
CMB signal, **6-2**
tracing at, **6-3**
executing programs, **3-10**
expressions
pattern and range resource, **2-7**
external analyzer, **1-3, 2-15**
definition, **1-1**
extension to emulation analyzer, **4-11/4-12**
independent state analyzer, **4-11, 4-14**
independent timing analyzer, **4-12**
selecting the mode, **4-11**
setup and hold times for qualifying signals, **4-16**
specifications, **4-17**

- external analyzer (cont'd)
 - timing analyzer, using the, **5-1**
 - trace labels, creating, **4-10**
 - using, **4-1**
- external timing analyzer, **1-4**
- F** features of the analyzer, **1-3**
- find state, **1-3, 2-4**
- G** glitch acquisition mode, **5-9**
- glitch trigger, **5-12, 5-14**
- global restart state, **2-5**
- grabbers
 - connecting to analyzer probe, **4-3**
- greater than duration, **5-12**
- H** halting the trace, **2-14**
- hexadecimal numbers, **2-8**
- hold times for qualifying signals, **4-16**
- holdoff, trigger, **5-10**
- I** instruction queues, **2-16**
- internal analyzer
 - definition, **1-1**
 - examples, **3-1**
 - using the, **2-1**
- interset operators, **2-12**
- intraset operators, **2-12**
- L** labels (external analyzer)
 - defining, **4-10**
- labels (timing)
 - defining, **5-5**
 - qualifying the timing specification, **5-11**
- less than duration, **5-12**
- line numbers, **2-15**
- loading absolute files, **3-9**
- logical AND/bitwise merge operator, **2-9**
- logical NOT, **2-12/2-13**
- M** memory
 - mapping for the sample program, **3-8**
 - mnemonic information in trace listing, **2-15**

modulo operator, **2-9**
multiply operator, **2-9**

N notes

Internal and External command options, **2-1**
monitors/adapters to display timing waveforms, **1-4**
threshold settings take effect when you begin the trace, **4-10**
timing interface software, **1-4, 5-1**
number bases, **2-8**

O occurrence counts, **2-5**

octal numbers, **2-8**
operators, **2-9**
 interset, **2-12**
 intraset, **2-12**
OR operator (bitwise), **2-9**

P pattern expressions, **2-12**

pattern resources, **2-10**
pattern trigger, **5-11**
pattern, timing specification, **5-12**
patterns, **2-7**
per level branches, **3-27**
pipelined architecture, **2-16**
predefined trace labels, **2-11**
prefetch, **2-16**
present for (duration), **5-12**
prestore (trigger holdoff), **5-10**
prestore qualifier, **2-6**
prestore qualifiers, **3-18**

Q qualified clock speed

 maximum, **4-16**
qualifiers
 count, **3-21**
 prestore, **3-18**
 storage, **3-15**

R range resource, **2-10**

READY, CMB signal, **6-2**
reference points, timing waveform display, **5-18**
 using the cursor to move, **5-18**
relative count display, **2-16**

- relative display of count information, **2-15**
- reset
 - emulation analyzer specification, **2-13**
 - timing specification, **5-14**
- restart on, **3-24**
- restart state, **2-5**
- rotate left operator, **2-9**
- rotate right operator, **2-9**
- running programs, **3-10**

S

- sample period, **5-9**
- sequence levels, **1-3, 2-2/2-3**
 - deleting, **2-3**
 - inserting, **2-3**
 - maximum, **2-3**
 - setting the trigger level, **2-3**
- sequencer, **1-3, 2-16**
- set operators
 - limitations, **2-13**
- setup times for qualifying signals, **4-16**
- shift left operator, **2-9**
- shift right operator, **2-9**
- simple measurements, **1-3**
- specifications
 - external analyzer, **4-17**
 - external timing analyzer, **5-20**
- standard acquisition mode, **5-9**
- starting the trace, **2-13**
- stat trace label, **2-11**
- status lines, predefined values for, **2-11**
- storage (trace), **1-3**
- storage qualifiers, **2-4, 3-15**
- subtract operator, **2-9**

T

- threshold voltages, **4-10, 5-4**
- time/division, timing waveform display, **5-17**
- timing analyzer
 - configuring the external analyzer, **5-2**
 - trace labels, creating, **5-5**
- timing analyzer, using the, **5-1**
- timing specification, **5-6**
 - reset, **5-14**

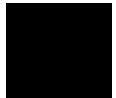

timing waveform display, **5-17**

trace

- at EXECUTE, **6-3**
- definition of, **1-1**
- description of listing, **2-15**
- displaying the, **2-14**
- halting the, **2-14**
- starting the, **2-13**
- window, **3-10**

trace format, **2-16**

trace labels, **2-10**

- external analyzer, creating, **4-10**
- timing analyzer, creating, **5-5**
- trace specification, **2-10**

trace specification

- count qualifier, **3-21**
- default, **2-2**
- modifying, **2-1**
- prestore qualifiers, **3-18**
- resetting the, **2-13**
- storage qualifiers, **3-15**
- trigger level, **3-11**

transitional acquisition mode, **5-7**

TRIG1, TRIG2 internal signals, **6-3**

trigger

- breaking into monitor on, **6-3**
- definition, **1-1**
- driving external signals on, **6-4**
- other combinations, **6-8**
- specifying a simple, **3-11**
- stop driving on break, **6-8**

trigger condition, **3-11**

- timing specification, **5-11**

trigger holdoff (prestore), **5-10**

trigger level

- setting the, **2-3**

trigger point, timing waveform display, **5-18**

trigger position, **2-7, 5-10**

- accuracy of, **2-7**

trigger state, **1-3, 2-4**

- TRIGGER, CMB signal, **6-2**
- TTL threshold voltage specification, **4-10, 5-4**
- U** unary one's complement operator, **2-9**
 - unary two's complement operator, **2-9**
 - user defined reference points, **5-18**
 - using the external timing analyzer, **5-1**
- V** values
 - assigning to pattern and range resources, **2-7**
 - values, predefined for emulator status, **2-11**
 - voltages, threshold, **4-10, 5-4**
- W** waveform (timing) display, **5-17**
 - window zoom, **3-10**
 - windows of program execution, tracing, **3-36**
- X** xbits, external analyzer trace label, **2-11, 2-15**
 - xbits, predefined timing label, **4-10, 5-5**
 - XOR operator (bitwise), **2-9**
- Z** zoom (windows), **3-10**

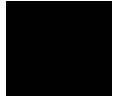

Notes

